

## QUANTUM WELL MULTIPLIERS: TRIPLERS AND QUINTUPLERS

M. A. Frerking

Jet Propulsion Laboratory  
California Institute of Technology  
Pasadena, California

Quantum well devices are a promising new type of non-linear device for harmonic generation in the millimeter and submillimeter wave regime. Two types of non-linear impedances have been employed for harmonic generation: the varactor with a non-linear capacitance-voltage characteristic and the varistor with a non-linear current-voltage (I-V) relationship. The harmonic generation efficiency of the varactor theoretically exceeds that for a varistor since an ideal varactor suffers no resistive losses. However, above about 400 GHz, currently available varistors are more efficient because they have considerably higher cutoff frequencies. The maximum conversion efficiency to the  $n$ th harmonic for an ideal varistor with a monotonically increasing I-V characteristic has been shown to be  $1/n^2$  [1,2]. The quantum well double barrier diode is a varistor which exhibits a negative resistance in its I-V curve at frequencies as high as 2.5 THz [3]. Since its I-V curve is no longer monotonically increasing, it can generate harmonics with higher efficiency than the  $1/n^2$  limit. Tripling to 200 GHz has been demonstrated with these devices with output powers in excess of 200  $\mu$ W [4,5, viewgraph 6 (VG-6)]. The capacitance - voltage characteristic of these devices is also highly non-linear and may provide efficient varactor operation. Theoretical analysis yields high efficiencies for tripling and quintupling of GaAs/AlAs and InGaAs/AlAs quantum well devices with optimized embedding impedances.

A quantum well resonant tunneling diode (RTD) is formed of two thin layers of a material with a high energy band gap on either side of a lower energy gap material. As shown in VG-2 this structure has a potential energy distribution consisting of a potential well sandwiched between two barriers. In such a structure a bound state can occur. When no voltage is applied to the RTD, no current flows. As the voltage is increased across the device electrons tunnel through the barriers. When the voltage equals that of the bound state resonant tunneling occurs greatly enhancing the current. As the voltage increases further, the resonance is passed and the current drops. When the voltage exceeds the barrier height the current again increases. Since the RTD structure is symmetric the I-V curve is antisymmetric about zero voltage.

Thin barrier RTDs are very fast devices. The charge-transport time can be less than 100 fs, while the intrinsic parasitics are low. Current densities as high as  $2 \times 10^5$  A/cm<sup>2</sup> have been achieved [6] and the specific capacitance of 0.1  $\mu$ F/cm<sup>2</sup> is comparable to high speed GaAs Schottky barrier diodes.

Frequency multiplication using these devices was first suggested by Sollner [7]. The shape of the I-V curve suggest that there should be large harmonic content to the current waveform, and the antisymmetry implies that only odd harmonics should be present. The differential negative resistance allows efficiency greater than  $1/n^2$  the limit for monotonically increasing I-V curves.

To design a multiplier using a quantum well RTD as the non-linear device, a large signal analysis was carried out using a modified version of GISSMIX [8, VG-8] to optimize terminations at the various harmonics. The large signal analysis was carried out at three output frequencies; DC, 183 GHz, and 1000 GHz. In addition three quantum well RTD devices were modelled; one GaAs/AlAs RTD and two InGaAs/AlAs RTDs. The device details are summarized in the VG-10,

VG-11, and VG-12.

At DC, where parasitics can be ignored so that the RTD is operating in a purely varistive mode, the 3<sup>rd</sup> and 5<sup>th</sup> harmonics had comparable efficiencies; 2.5% for the GaAs/AlAs RTD and 7% for the InGaAs/AlAs RTD [VG-15, VG-16].

To verify the large signal theoretical analysis, measurements of multiplication efficiency were also performed at low frequencies. The agreement between experiment and theory is excellent, not only for the 3<sup>rd</sup> and 5<sup>th</sup> harmonics, but also for the 7<sup>th</sup>, 9<sup>th</sup>, and 11<sup>th</sup> harmonics [VG-15].

In the submillimeter wavelength regime, the effect of parasitics is critical. The two most important parasitics are the series resistance and the shunt capacitance [VG-17]. The series resistance arises from the ohmic contact, the resistance of the undepleted epilayers on both sides of the double barrier structure, and spreading resistance from the mesa into the much wider substrate material. The voltage variable capacitance occurs in the depletion region. The functional form indicated in VG-17 is a simple solution to Poisson's equation.  $C_{j0}$  is the capacitance of the double barrier structure when no voltage is applied.

For varistor operation to dominate, the time averaged impedance due to the capacitance must be less than the resistive impedance of the quantum well device. These limits are shown graphically in VG-18. The resistive impedance of the device depends on the detailed shape of the I-V curve and the voltage swing of the pump power. For the devices we have tested, it is in the range 100 - 300  $\Omega$ s. An average capacitance of less than 5 fF is required for varistor operation at 100 GHz while an average capacitance of less than 1 fF is needed for varistor operation at 1000 GHz.

The predicted voltage variable capacitance of the quantum well device is highly non-linear, suggesting that these devices may perform extremely well as varactors. VG-20 and VG-21 show the predicted performance of the InGaAs/AlAs RTD at three frequencies, DC, 183 GHz, and 1000 GHz. At DC the device is operating in the purely varistor mode whereas at 183 GHz it is functioning primarily as a varactor. The 5<sup>th</sup> harmonic generation efficiency is greater at 183 GHz (about 25%) than at DC (about 7 %) since varactor operation allows the build up of higher instantaneous current in the device. This can be seen by comparing the current waveforms at DC (VG-13) and at 183 GHz (VG-19). At 1000 GHz the series resistance is limiting the performance as a varactor yielding lower efficiencies.

With the existing GaAs/AlAs and InGaAs/AlAs RTDs, power levels on the order of 0.25 to 0.5 mW can be generated at the 5<sup>th</sup> harmonic when provided the proper embedding circuit. The output power scales with current density. Current densities almost an order of magnitude higher have recently been demonstrated in the new material system InAs/GaAlSb [6].

In summary, quantum well devices are a promising new millimeter and submillimeter wave frequency multiplier device. They can be optimized to maximize performance as a high order harmonic generator. In particular 5<sup>th</sup> order harmonic generation is very efficient. Since their inherent symmetry produces only odd harmonics, circuit design is greatly simplified. We have verified varistor multiplication at very low frequencies by comparing large signal theoretical analysis with experimental measurement. Understanding the parasitics is critical to optimizing for high frequency performance. The voltage variable capacitance of quantum well devices may in fact make them a very good candidate varactor.

### References

1. C. H. Page, "Frequency conversion with positive nonlinear resistors," *J. Res. Nat. Bur. Stand.*, vol. 56, no. 4, p. 179, Apr. 1956.
2. C. H. Page, "Harmonic generation with ideal rectifiers," *Proc. IRE*, vol. 46, pp. 1738-1740, Oct. 1958.
3. T. C. L. G. Sollner *et. al.*, "Resonant tunneling through quantum wells at frequencies up to 2.5 THz," *Appl. Phys. Lett.*, vol. 45, p. 1319, 1984.
4. P. D. Batelaan and M. A. Frerking, "Quantum well multipliers," Twelfth International Conference on Infrared and Millimeter Waves Digest, p. 14-15, Dec. 1987.
5. A. Rydberg and H. Gronqvist, "Quantum-well high-frequency millimetre-wave frequency tripler," *Electronics Letters*, Vol 25, No. 5, p. 348, Mar. 1989.
6. T. Broekaert and C. Fonstad, *IEEE Int. Electron Devices Meeting Tech. Digest*, (IEEE, New York), paper 21.5, 1989.
7. T. C. L. G. Sollner, E. R. Brown, and H. Q. Le, "Microwave and Millimeter-Wave Resonant-Tunneling Devices," *Lincoln Laboratory Journal*, Vol. 1, No. , 1988.
8. P. H. Siegel, "Topics in the Optimization of Millimeter-Wave Mixers," NASA Technical Paper 2287, Mar.1984.

# QUANTUM WELL MULTIPLIERS

**JPL**

**M. A. Frerking**

**March 7, 1990**

**Collaborators:**

**JPL**

**P. Batealan**

**T. Tolmunen**

**Lincoln Laboratory**

**E. Brown**

**G. Sollner**

**Sponsor:**

**NASA OAST Sensors Program**

# SUBMILLIMETER WAVE LOCAL OSCILLATOR

- TECHNICAL GOALS

- Local Oscillator Sources for 300 - 1500 GHz
- Output Power 1  $\mu$ W - 1 mW
- Tuneability 10-20 %
- Linewidth 1:10<sup>8</sup>
- Frequency Stability 1:10<sup>8</sup>
- Space Qualifiable

- TECHNICAL APPROACH

- Solid State Source - Quantum Well Device
- Fundamental Oscillator 300 - 600 GHz
- Harmonic Generator 600 - 1500 GHz

# DOUBLE BARRIER TUNNELING IN QUANTUM WELL DEVICES

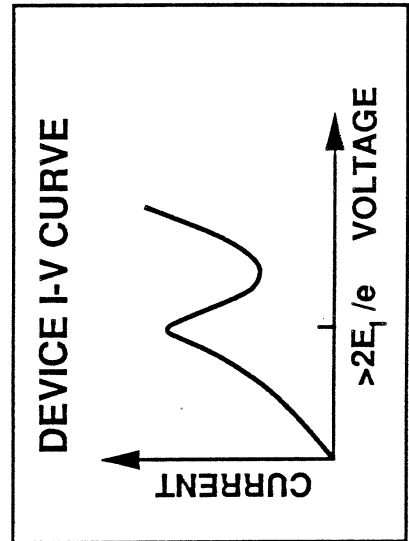
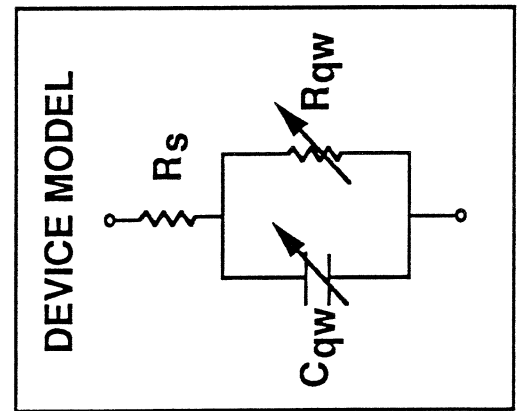
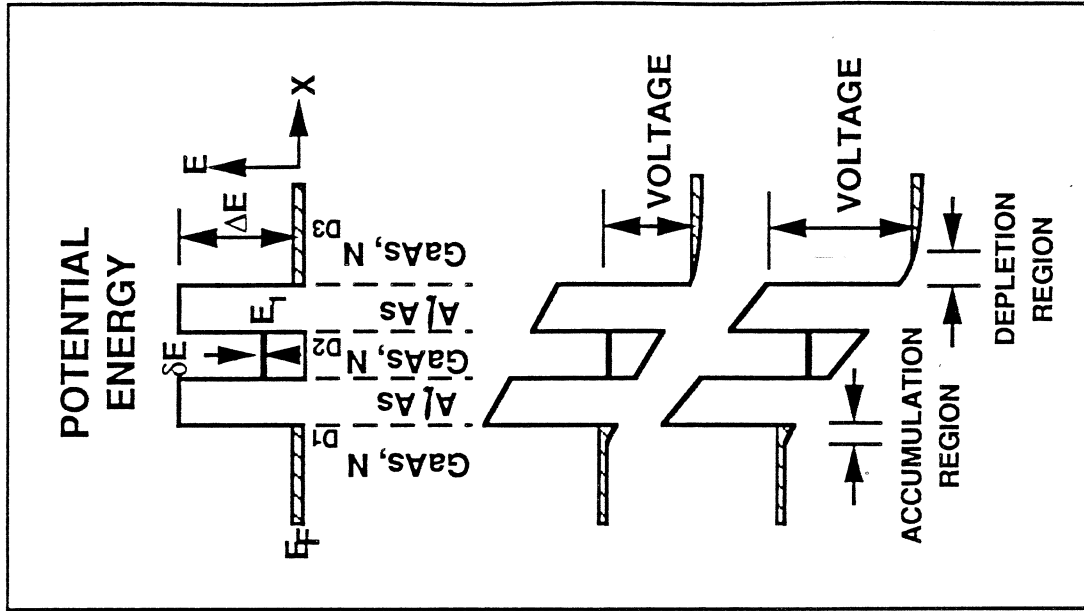
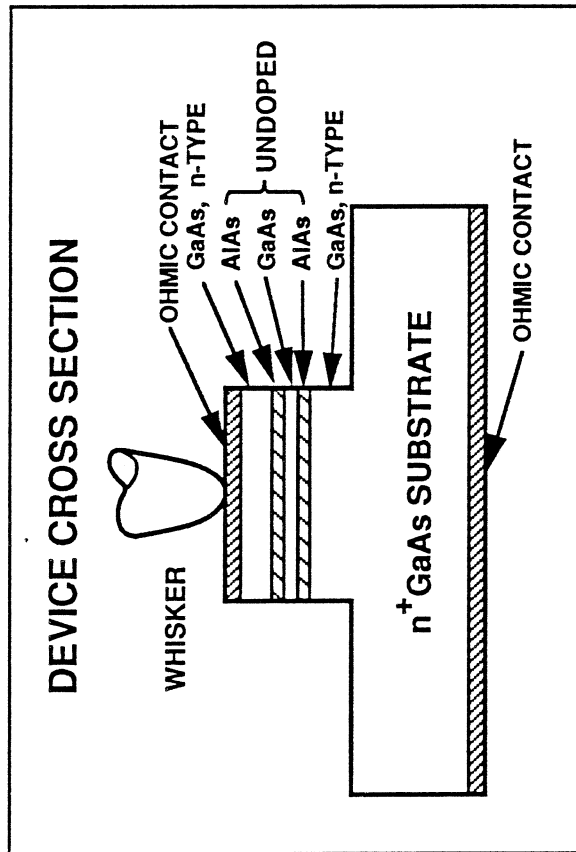

## ADVANTAGES OF QUANTUM WELL DEVICES

- High Speed
  - Quantum Limit < 100 fs
  - $\tau \sim 2\hbar/\Delta E$
- Low Parasitics
  - High Current Density  $\sim 1.5 \times 10^5 \text{ A/cm}^2$
  - Low Capacitance  $\sim 0.1 \text{ } \mu\text{F/cm}^2$
- Unique Current Voltage Characteristic
  - Negative Differential Resistance
  - Antisymmetric about zero
- Engineered Device

# MULTIPLICATION USING QUANTUM WELL DEVICES

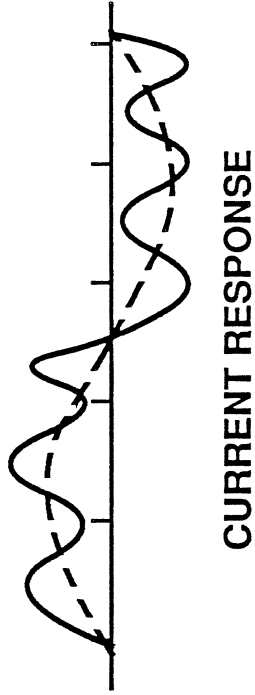
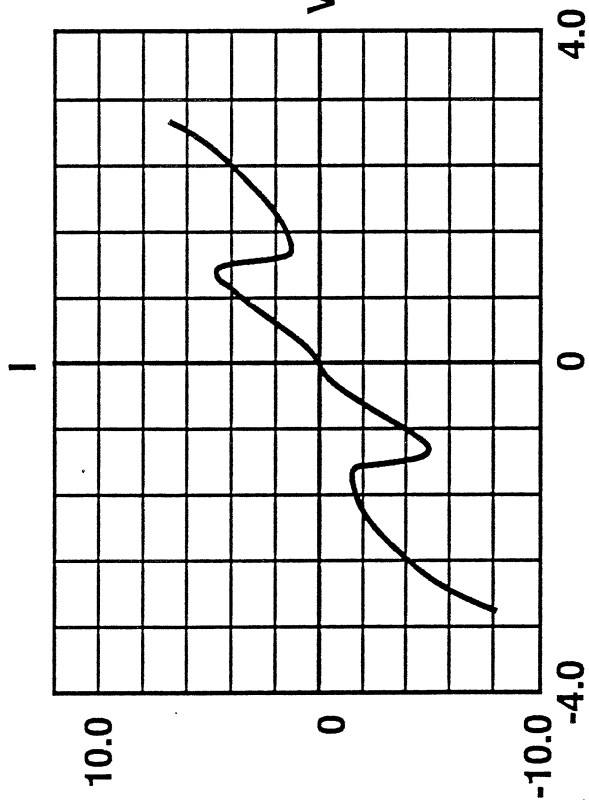

## ADVANTAGES

- UNIQUE IV CURVE → EFFICIENCY  $> 1/n^2$
- ANTISYMMETRIC IV CURVE → ODD ORDER ONLY
- EFFICIENT HIGH ORDER MULTIPLICATION
- TAILORABLE DEVICE – OPTIMIZE SHAPE
- SPEED EQUIVALENT TO "MIXER" MULTIPLIER DIODES

## APPLIED VOLTAGE

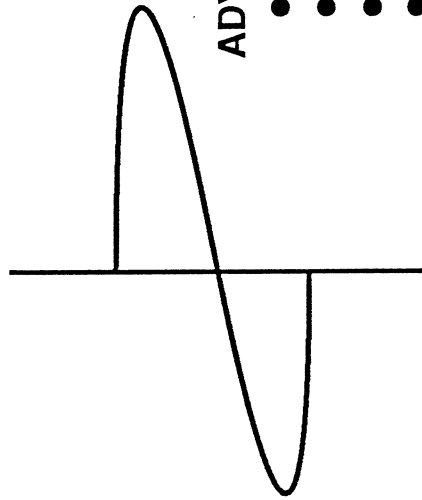



# JPL QUANTUM WELL TRIPLER

JPL

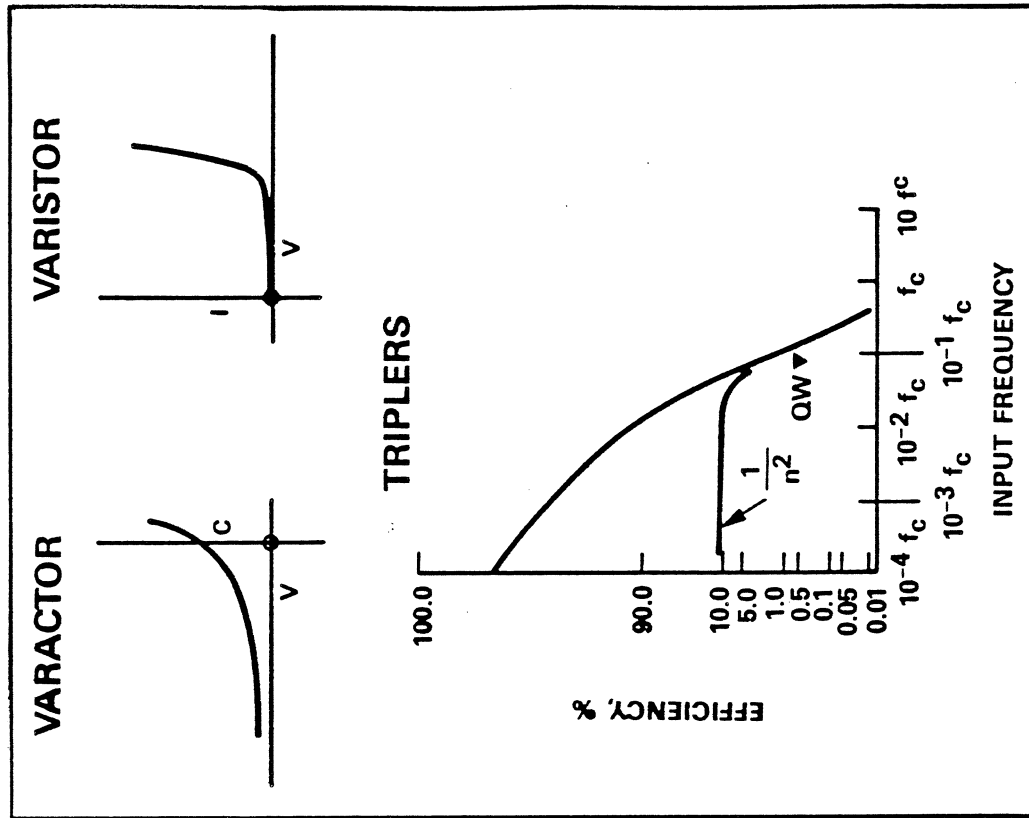
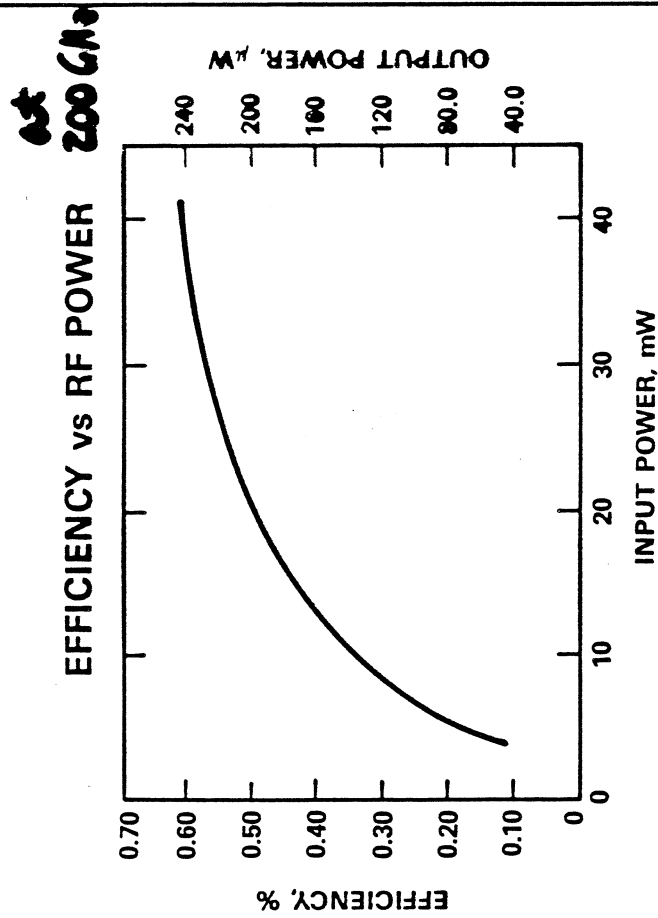

# LARGE SIGNAL ANALYSIS

- USE MODIFIED GISSMIX PROGRAM TO OPTIMIZED TERMINATIONS AT VARIOUS HARMONICS

- INPUTS

- QW MEASURED IV CURVE
- QW CALCULATED CV CURVE
- PUMP POWER
- DC BIAS POWER
- CIRCUIT EMBEDDING IMPEDANCES

- OUTPUTS

- VOLTAGE AND CURRENT WAVEFORMS
- HARMONIC GENERATOR EFFICIENCY
- HARMONIC POWER

- VERIFIED PROGRAM BY COMPARISON TO ANALYTICAL SOLUTION FOR PURELY RESISTIVE DEVICE

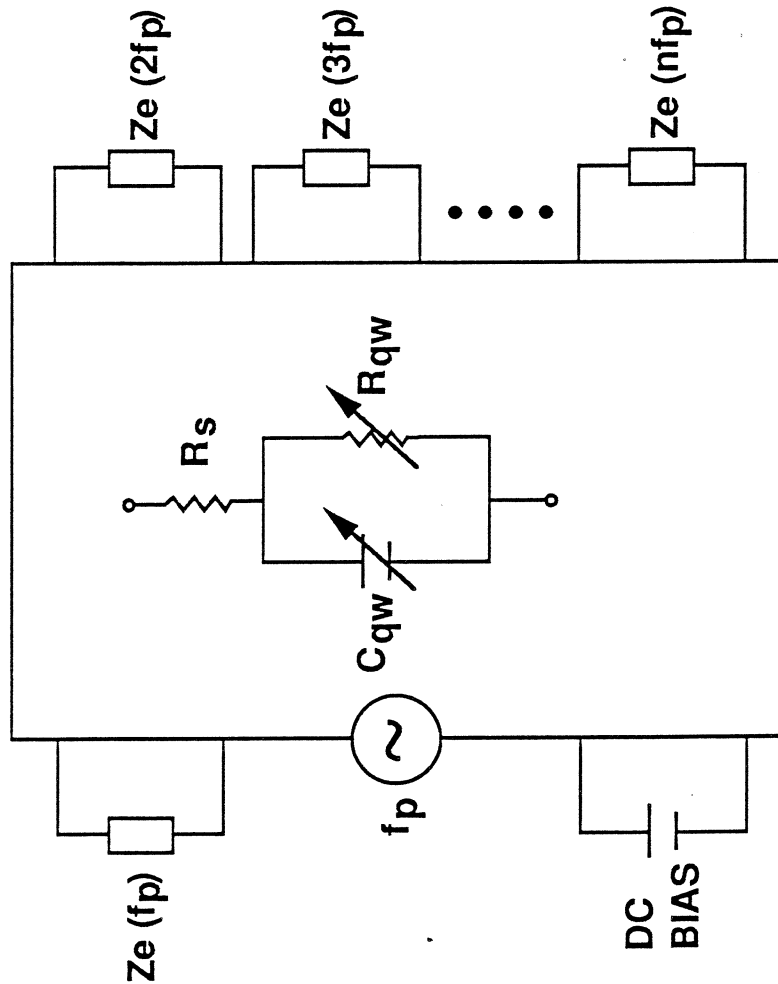

## LARGE SIGNAL ANALYSIS

- **Frequencies**
  - Low Frequency - no parasitics
  - Millimeter Wave - Quintupler to 183 GHz
  - Submillimeter Wave - Quintupler to 1000 GHz
  
- **Quantum Well Devices**
  - GaAs/AIAs RTD - existing device
  - InGaAs/AIAs RTD - existing device
  - InGaAs/AIAs RTD - hypothetical, but possible

# GaAs/AIAs Quantum Well Resonant Tunneling Diode

Devices obtained from Lincoln Laboratory

Device Detail

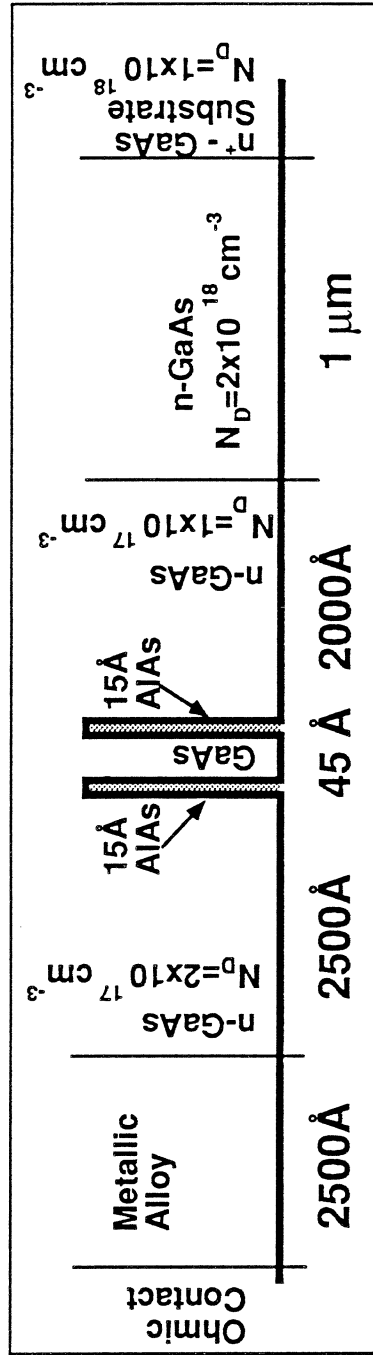

Device Parameters

- $J_p = 4 \times 10^4 \text{ A/cm}^2$
- $I_p/I_v = 3.5:1$
- Diameter =  $4 \mu\text{m}$
- $R_s = 12 \Omega$
- $C_{eff} = 1/\{1/C_{min} - 1/C_{max}\} = 12 \text{ fF}$
- $f_c = 1/2\pi R_s C_{eff} = 1140 \text{ GHz}$

Device I-V Curve

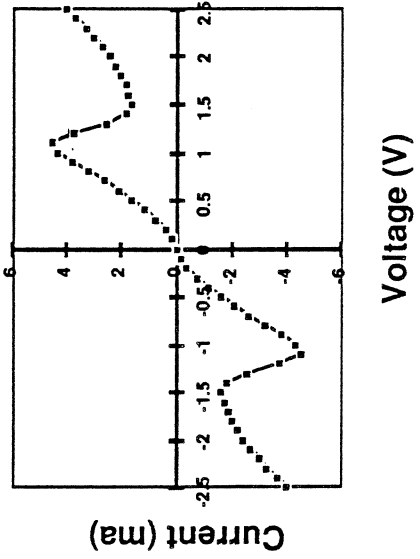

# InGaAs/AlAs Quantum Well Resonant Tunneling Diode

DEVICES OBTAINED FROM LINCOLN LABORATORY

## DEVICE DETAIL

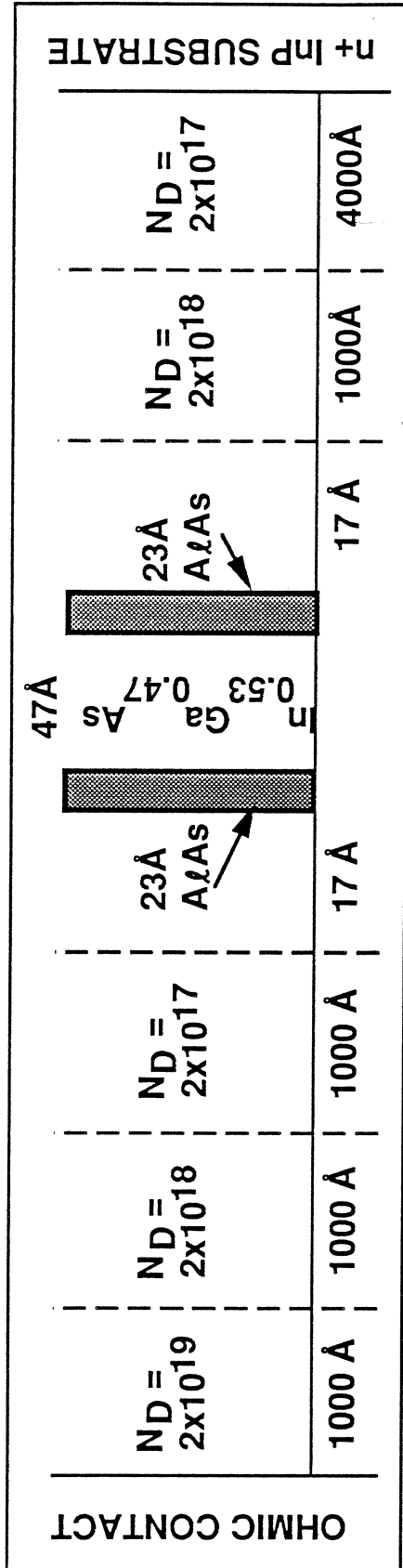

## Device Parameters

- $J_p = 3 \times 10^4 \text{ A/cm}^2$
- $I_p/I_v = 10:1$
- Diameter = 3  $\mu\text{m}$
- $R_s = 12 \Omega$
- $C_{eff} = 1/\{1/C_{min} - 1/C_{max}\} = 7 \text{ fF}$
- $f_c = 1/2\pi R_s C_{eff} = 1890 \text{ GHz}$

## Device I-V Curve

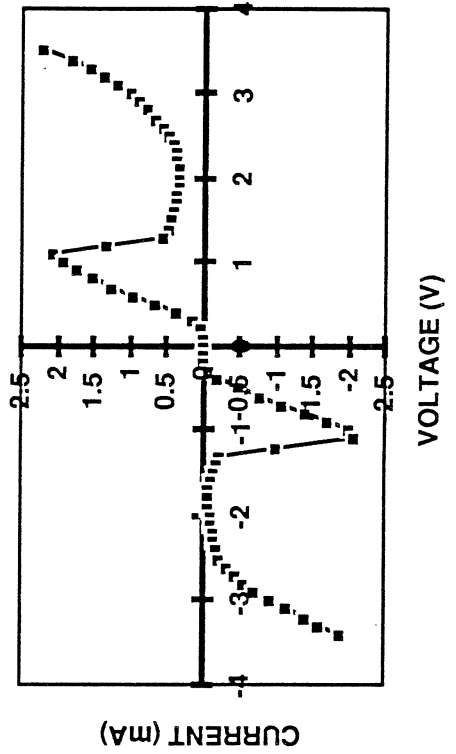

# HYPOTHETICAL QUANTUM WELL RESONANT TUNNELING DIODE

## DEVICE PARAMETERS

$$J_p = 3 \times 10^5 \text{ A/cm}^2$$

$$I_p / I_V = 10:1$$

$$\text{DIAMETER} = 1 \mu\text{m}$$

$$R_s = 5 \Omega$$

$$C_{\text{eff}} = 1 / \{1/C_{\text{min}} - 1/C_{\text{max}}\} = 1 \text{ fF}$$

$$f_c = 1/2 \pi R_s C_{\text{eff}} = 29 \text{ THz}$$

# MULTIPLIER OPERATION: WAVEFORMS

Low Frequency Case

GaAs/AIAs RTD

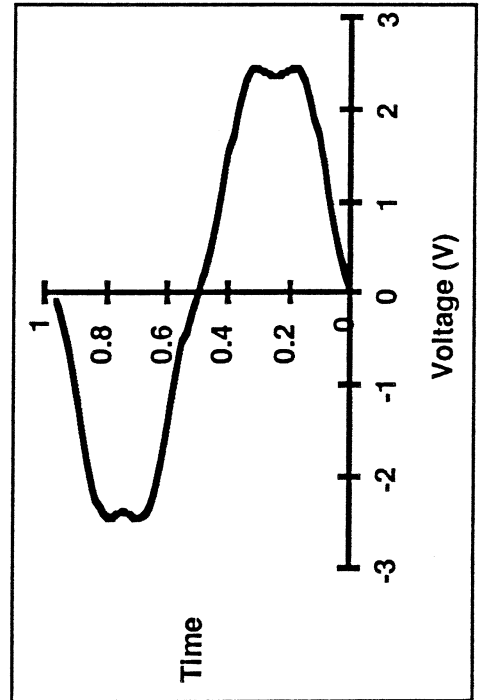
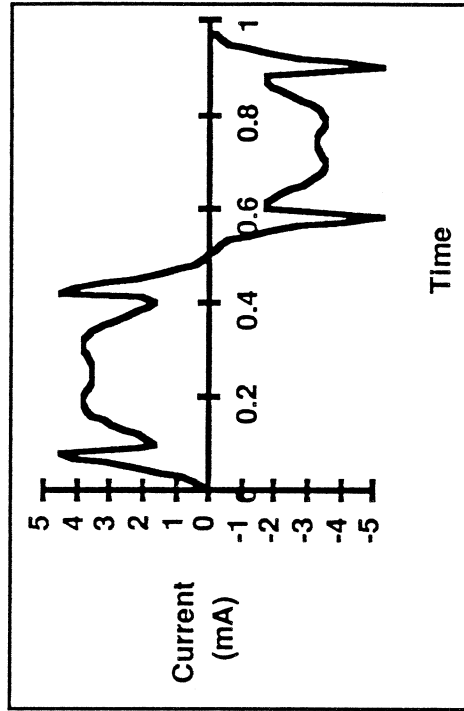
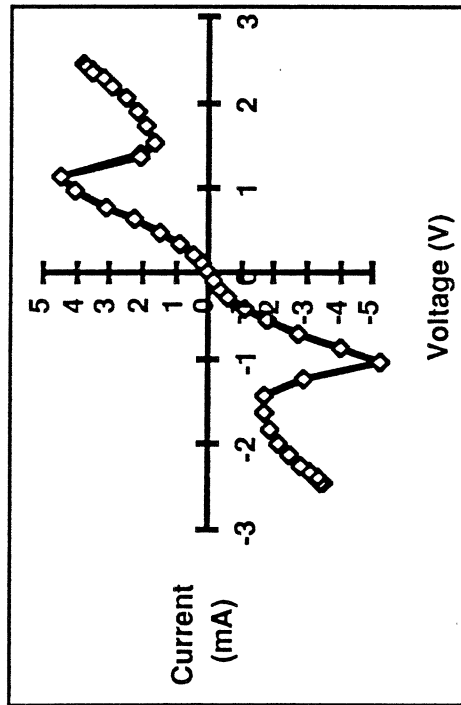

# LOW FREQUENCY EXPERIMENTAL VERIFICATION

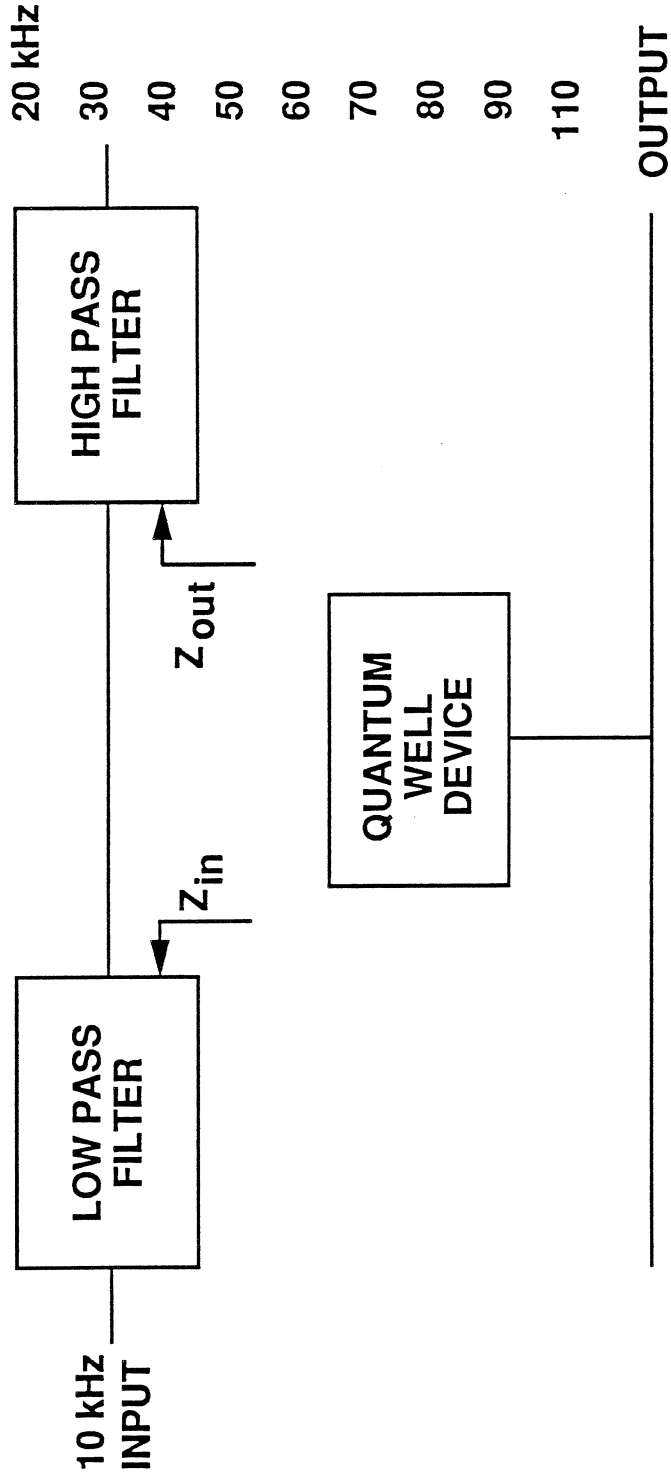



# LOW FREQUENCY VERIFICATION THEORY AND MEASUREMENT

GaAs/AIAS RTD

--- THEORY

—■— MEASUREMENT

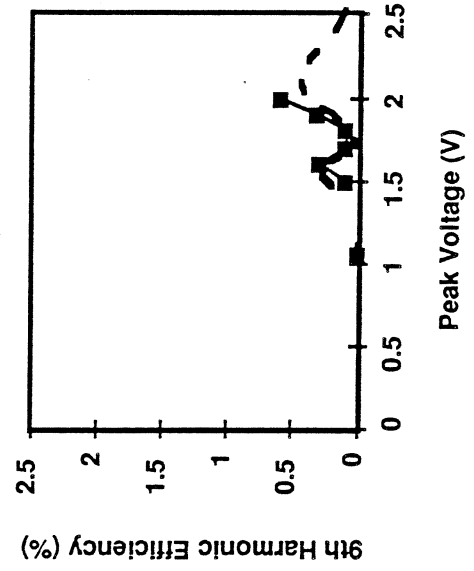
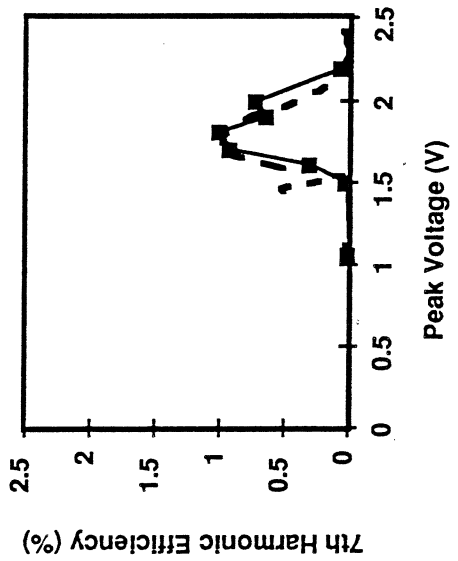
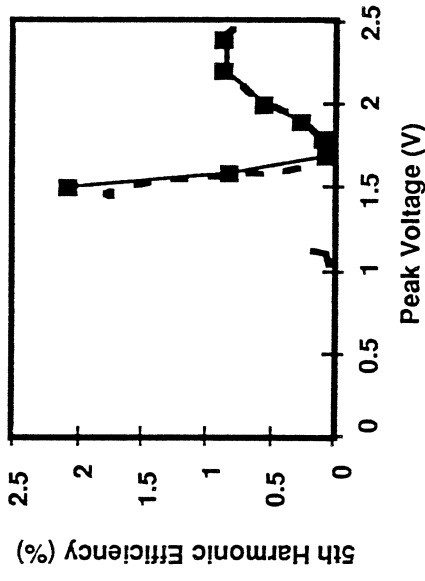
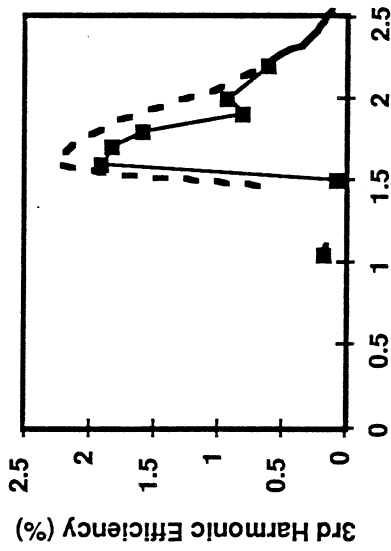

# COMPARISON of InGaAs/AIAs and GaAs/AIAs RTDs

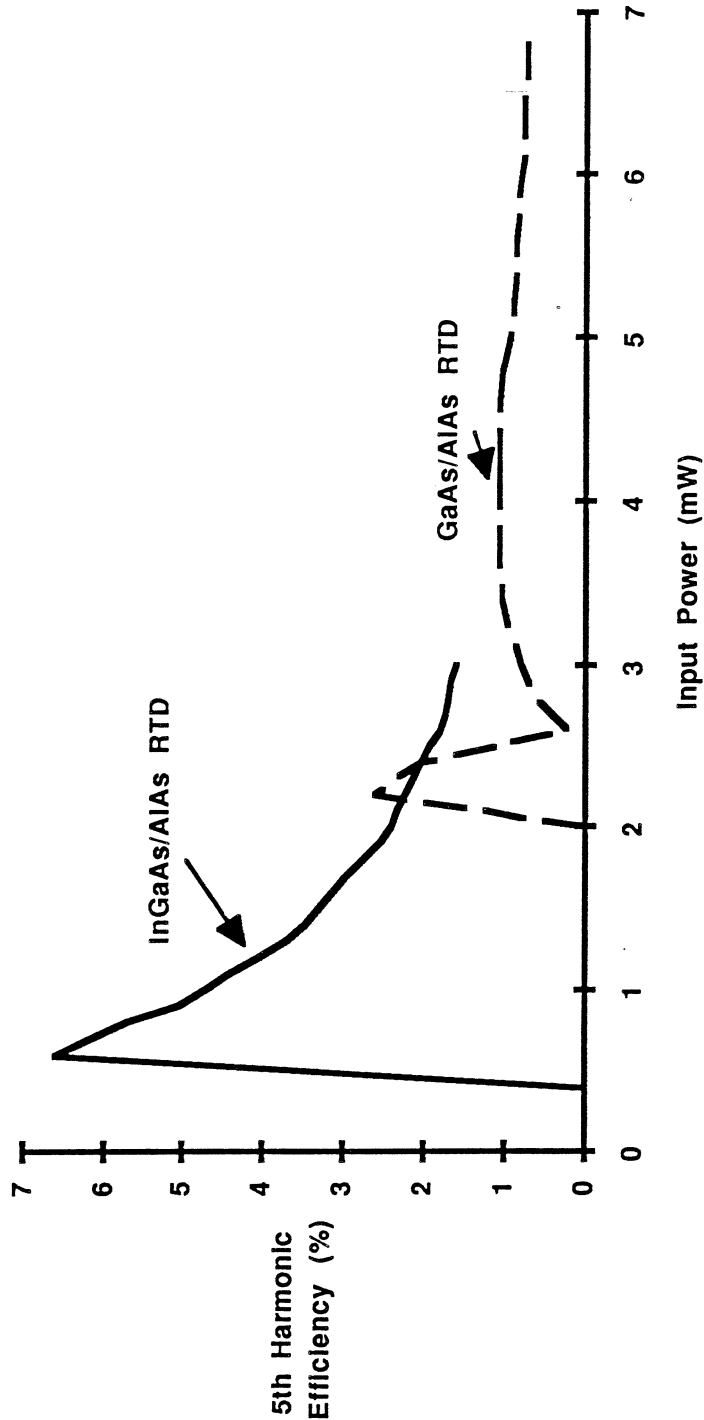

# PARASITICS

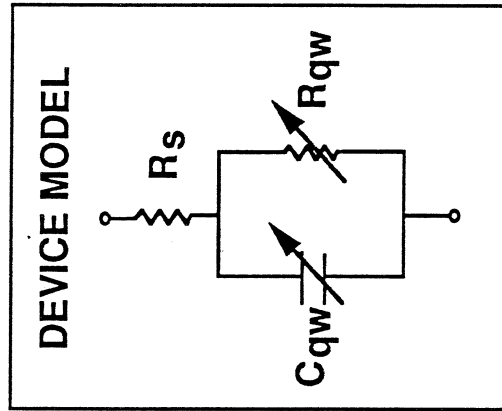

## SERIES RESISTANCE

$$R_s = R_{\text{contact}} + R_{\text{epi}} + R_{\text{spread}}$$

$$R_{\text{contact}} = \rho_c / A$$

$$R_{\text{epi}} = \rho_{\text{epi}} L / A$$

$$R_{\text{spread}} = \frac{\rho_{\text{substrate}}}{2d}$$

Quantum Well Double Barrier Diode C-V Curve

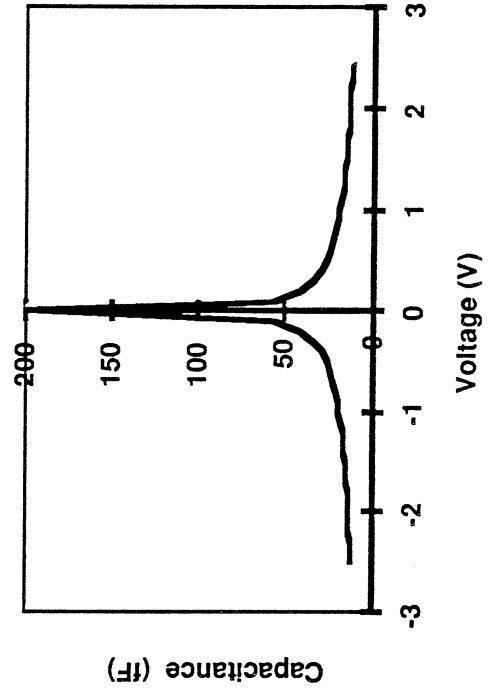

## SHUNT CAPACITANCE

$$C = \frac{\epsilon A}{W + D}$$

$$C_{j0} = \frac{\epsilon A}{W}$$

$$C = \frac{C_{j0}}{\sqrt{1 + \left( \frac{2\epsilon}{eN_D W^2} \right) V}}$$

# Requirement for Varister Multiplication

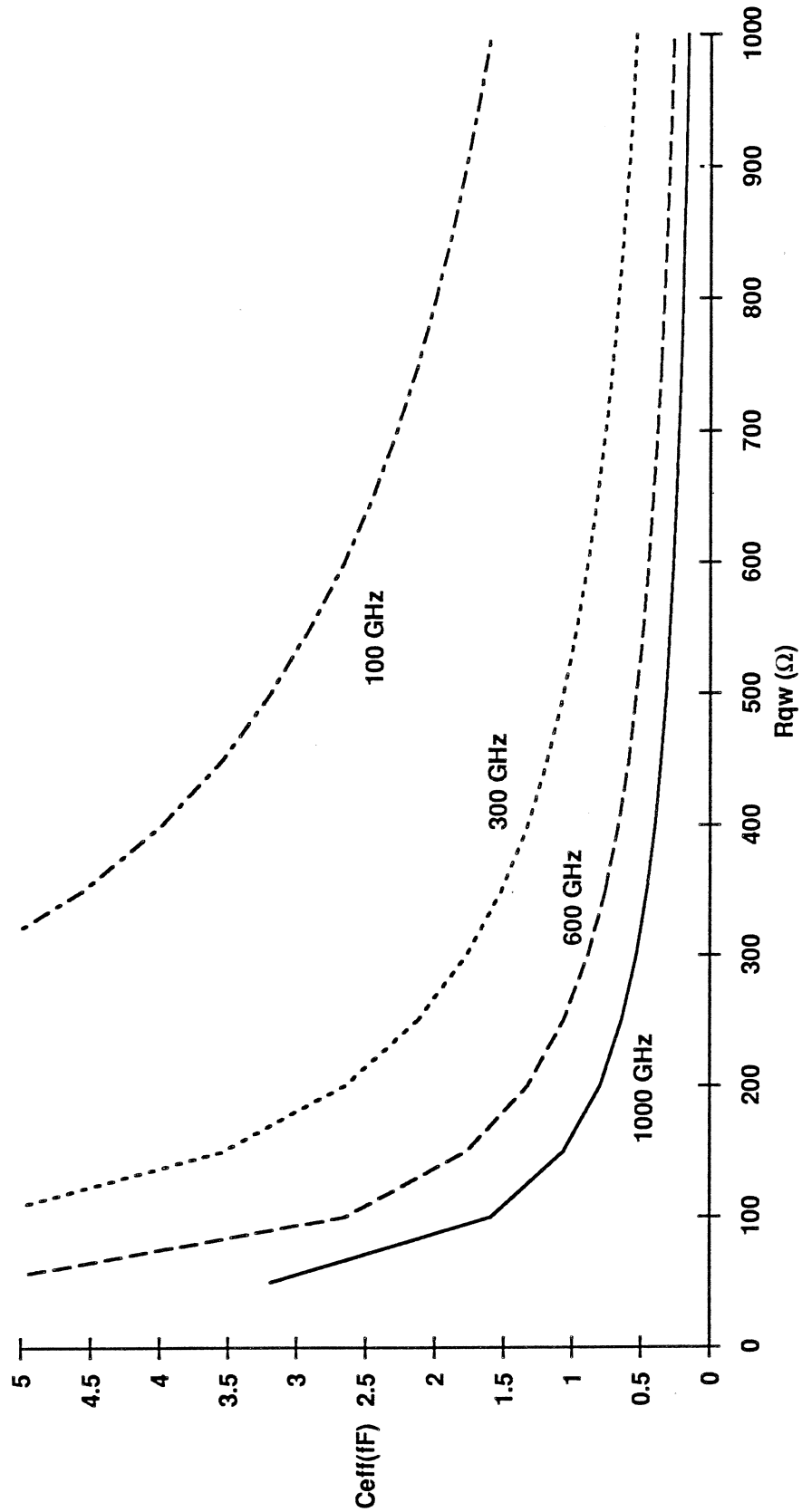

# MULTIPLIER OPERATION: WAVEFORMS

183 GHz Case

GaAs/AIAS RTD

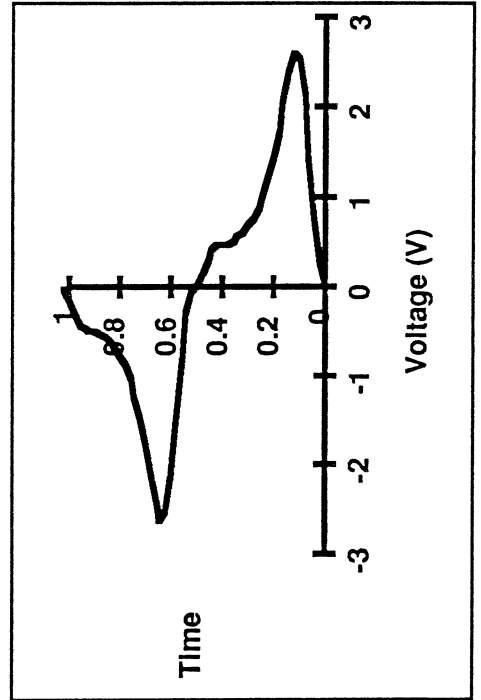
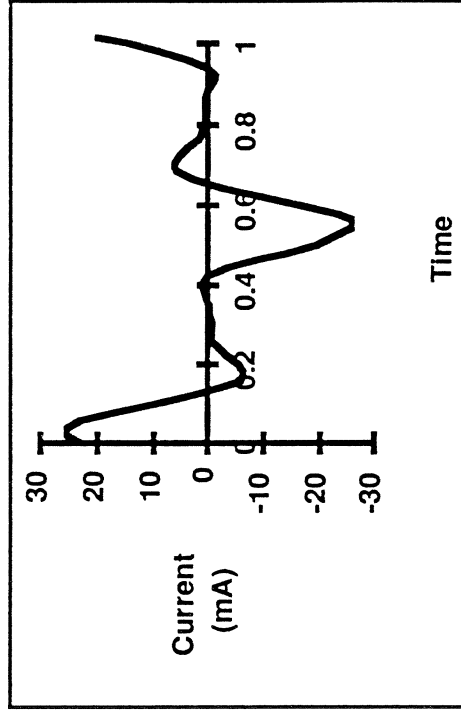
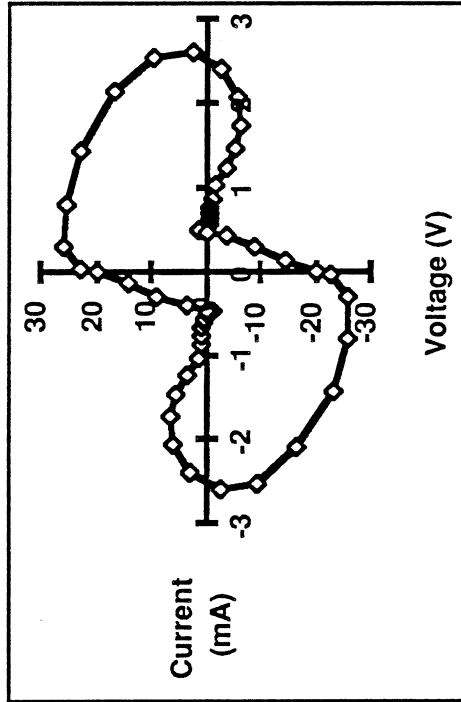

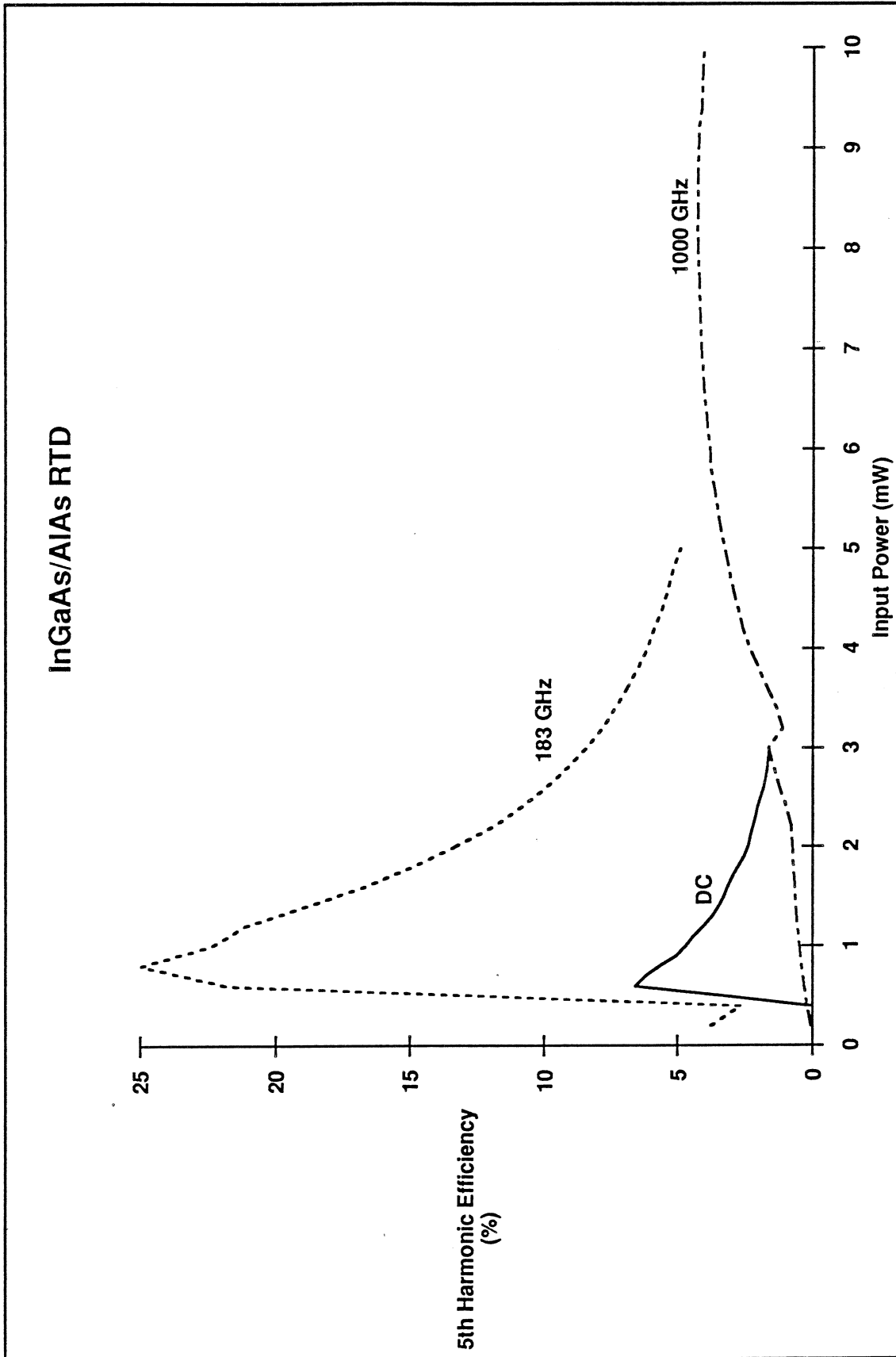

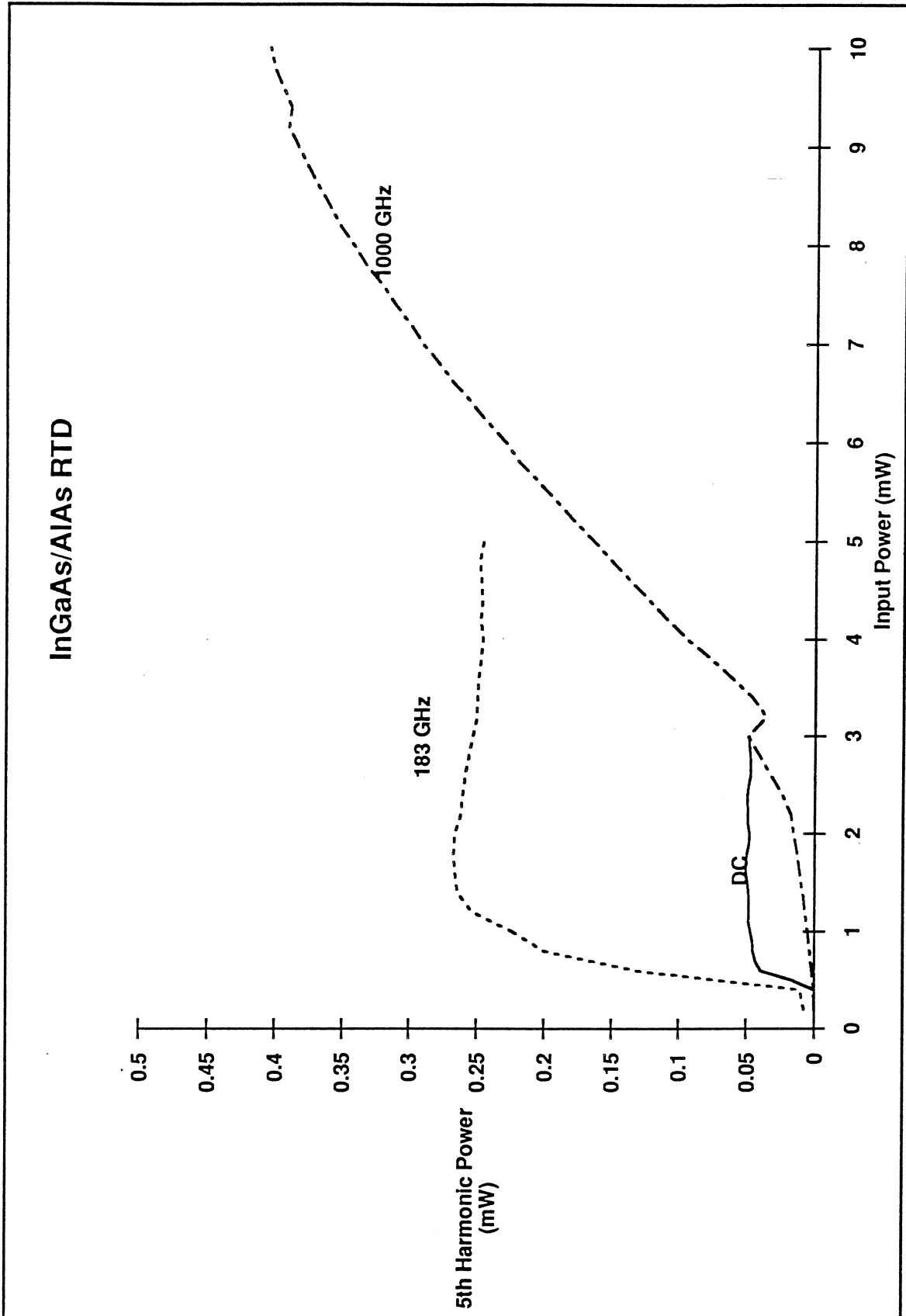

## **SUMMARY**

- **Quantum Well Devices are a Promising Millimeter and Submillimeter Wave Frequency Multiplier**
  - **Tailorable Device**
  - **High Order Harmonic Generator**
  - **Odd Harmonics only**
  
- **Verified Varister Multiplication at Low Frequencies**
  - **Large Signal Analysis**
  - **Experimental Measurement**
  
- **Parasitics are Critical to High Frequency Performance**
  
- **Quantum Well Devices May Function as Varactors as well**