

## Submillimeter Wavelength Waveguide Mixers Using Planar Schottky Barrier Diodes

Jeffrey L. Hesler<sup>†</sup>, William R. Hall<sup>†</sup>, Thomas W. Crowe<sup>†</sup>,  
Robert M. Weikle, II<sup>†</sup>, and Bascom S. Deaver, Jr.<sup>‡</sup>  
Departments of Electrical Engineering<sup>†</sup> and Physics<sup>‡</sup>  
University of Virginia  
Charlottesville, VA 22904

Richard F. Bradley and Shing-Kuo Pan  
National Radio Astronomy Observatory\*  
Charlottesville, VA 22903

### Abstract

This paper discusses the design, construction, and testing of submillimeter wavelength waveguide mixers using planar Schottky diodes. A finite element method program was used to determine the effect of the planar diode chip on the mixer performance. Mixers using the UVa SCIT5 planar diode were designed at both 585 and 690 GHz. A system noise temperature of 2380 K (DSB) was measured at 585 GHz, and a system noise temperature of 3110 K (DSB) was measured at 690 GHz. In addition, the 585 GHz mixer was cooled to both 77 K and 4.2 K, with measured system noise temperatures of 1250 K (DSB) and 880 K (DSB), respectively. The modeling techniques used were found to predict the measured conversion loss to within several dB. The performance of planar diodes is now within a factor of 1.5 of the best whisker-contacted Schottky diode results in this frequency range [1].

### Introduction

Planar Schottky diodes can be used to build simple and reliable receivers that operate at room temperature with excellent sensitivity. However, at submillimeter wavelengths, the parasitic impedances associated with the planar diode structure complicate mixer design, and it has been difficult to obtain performance comparable to the best whisker-contacted Schottky mixers. The ultimate goal of this research is to understand the effect of the planar diode geometry on mixer operation, and to determine how best to design the diode chip and mixer circuitry for optimum performance.

In particular, this paper describes the design, fabrication and testing of waveguide receivers at 585 and 690 GHz using state-of-the-art planar Schottky diodes [2,3]. The basic design procedure for the mixer, which includes numerical

---

\*The National Radio Astronomy Observatory is operated by Associated Universities, Inc. under cooperative agreement with the National Science Foundation.

modeling of the diode and mixer circuitry using Hewlett Packard's High Frequency Design Software, is described. Receiver test results at both 585 and 690 GHz and cryogenic test results for the 585 GHz mixer at both 77 K and 4.2 K are presented. In order to gauge the accuracy of the modeling techniques used, the mixer losses are estimated, and the modeling predictions are compared with the measured results.

### **Basic Mixer Configuration**

The mixer block design, shown schematically in Fig. 1, was originally developed for use with SIS junctions. The block used during this research was fabricated at Rutherford-Appleton Laboratory using direct machining techniques. The LO and RF signals are coupled into a 200 by 400  $\mu\text{m}$  waveguide by a diagonal feedhorn [4] which is integrated into the mixer block. The transition from waveguide to microstrip was designed using a scale model at 3.3-4.9 GHz, and exhibited a return loss of greater than 25 dB over the full waveguide band. An IF and DC return to ground is provided by a 25  $\mu\text{m}$  gold wire bonded to the microstrip which is shorted in indium at the end of a quarter wave side channel. The diode, a UVa SC1T5 planar diode with  $2 \cdot 10^{17} \text{ cm}^{-3}$  epitaxial layer doping and 1.2  $\mu\text{m}$  anode diameter, is mounted across a gap in the microstrip. The distance between the gap and the low pass filter was used as the main mixer tuning element, as discussed below.

### **Diode Modeling and Circuit Design**

The equivalent circuit of Schottky junctions has been extensively investigated and is rather well understood. However, the parasitic impedances created by the planar diode chip structure can also have a great impact on receiver performance. To determine the effect of the diode chip, Hewlett Packard's High Frequency Structure Simulator (HFSS) was used to solve for the fields of the diode mounted in the microstrip channel. By adding a small coaxial probe near the anode and solving for the fields, the junction embedding impedance can be determined directly from the HFSS solution. Fig. 2 shows a schematic of the area near the anode with a coaxial probe inserted to determine embedding impedance.

Once the variation of the diode's embedding impedance with system parameters was determined, the harmonic balance routines in MDS were used to design the RF/LO coupling structures for the diodes. Typical diode parameters for an SC1T5 diode are:  $R_s = 14 \Omega$ ,  $\eta = 1.17$ ,  $I_{\text{sat}} = 3 \cdot 10^{-17} \text{ A}$ , and  $C_{j_0} = 2 \text{ fF}$ . The values for  $R_s$ ,  $\eta$  and  $I_{\text{sat}}$  were determined by a least squares fit of the measured diode I-V to the non-linear diode equation. The mixer simulations include plasma resonance and skin effect by the addition of a complex series resistance. The mixer simulations at 585 GHz (assuming no circuit losses) predict a conversion loss minimum of 3.4 dB (DSB) for an RF embedding impedance of  $50 + j60 \Omega$ , and a mixer noise temperature minimum of 155 K (DSB) at  $40 - j10 \Omega$ . The simulations predict similar performance for this diode at 690 GHz.

A schematic of the basic mixer microstrip configuration is shown in Fig. 3. On

one side of the diode is a length of transmission line,  $l_{\text{match}}$ , between the diode and the low pass filter. The low pass filter presents an open circuit at its input to the LO and RF signals. On the other side of the diode is a length of microstrip line running to the waveguide transition. This mixer circuit configuration thus offers 3 main variables for tuning:  $Z_{\text{source}}$ ,  $Z_{\text{match}}$  and  $l_{\text{match}}$ . Other important factors in determining the embedding impedance are the width of the gap across which the diode is mounted ( $l_{\text{gap}}$ ), the diode chip geometry (e.g. finger length), and the diode mounting (e.g. solder thickness). The mixer circuit chosen at 585 GHz for the SC1T5-S10 diode (10  $\mu\text{m}$  finger length) had  $Z_{\text{source}} = Z_{\text{match}} = 50 \Omega$ ,  $l_{\text{gap}} = 60 \mu\text{m}$ , and  $l_{\text{match}} = 150 \mu\text{m}$ , yielding a predicted embedding impedance of  $45 + j30 \Omega$ , a mixer conversion loss of 3.8 dB (DSB) and a noise temperature of 350 K (DSB), assuming no transmission line losses in the mixer. The simulations also indicated that this mixer design has a 3 dB conversion loss bandwidth of approximately 110 GHz.

### Mixer Assembly and Receiver Test Setup

The microstrip circuits were fabricated on 35  $\mu\text{m}$  thick quartz substrates. The thin quartz wafer was mounted with wax on a silicon support wafer. The quartz was sputtered with a metal seed layer of approximately 50 Å of chrome followed by 2000 Å of gold (the chrome layer aids the adhesion of the gold to the quartz). A layer of positive photoresist was then patterned onto the surface, leaving clear the areas where the microstrip circuits will be. Gold was then electroplated onto the microstrip regions to a thickness of about 2-3  $\mu\text{m}$ . The photoresist was removed and the seed layer of gold and chrome was sputtered away. The quartz wafer was diced into individual circuits before being removed from the silicon carrier. The IF/DC connection wires were then bonded onto the choke and the diode was soldered across the gap. Finally, the quartz structure was mounted into the mixer block and held in place by the wires which were pressed into indium. A picture of a quartz choke mounted in a mixer block is shown in Fig. 4.

A schematic of the quasi-optical test setup used to measure the mixer performance is shown in Fig. 5. A Martin-Puplett diplexer [5] and an off-axis parabolic mirror with a focal length of 60 mm are used to couple the LO and RF power into the feed horn. The LO power is supplied by an FIR gas laser which is in turn pumped by a CO<sub>2</sub> gas laser. The system noise temperature is measured using the Y-factor method, alternating between room temperature and 77 K absorber. The IF signals are amplified by an IF chain centered at 1.8 GHz and then fed into a crystal detector. The IF chain has a variable attenuator which can be used to vary the IF noise temperature, thus allowing calculation of the mixer noise temperature and conversion loss. In order to match the diode's IF impedance (typically about 150  $\Omega$ ) to the IF chain, a quarter-wave microstrip IF impedance transformer was designed. The measured IF return loss of the transformer was typically greater than 20 dB.

Testing was also performed at cryogenic temperatures in an Infrared Laboratories HD-3(8) dewar, pictured in Fig. 6. The mixer block, IF impedance

transformer, bias tee, isolator, and a low-noise amplifier are mounted on the cold work surface, which can be cooled to liquid nitrogen and liquid helium temperatures. The LO and RF power enters the dewar through a Teflon window (not shown), and the IF signal is output through a stainless steel semirigid coaxial cable for further amplification by the IF chain.

### **Room Temperature Results at 585 and 690 GHz**

The best mixer results achieved to date at 585 GHz were obtained using the SC1T5-S10 diode, although similar results were obtained with the 5 and 20  $\mu\text{m}$  finger length SC1T5 diodes. A double sideband (DSB) receiver noise temperature of 2380 K and mixer conversion loss of 7.6 dB were measured using less than 0.5 mW of LO power. A plot of the system noise temperature versus LO power is shown in Fig. 7. The arrow on the horizontal axis marks the power at which the system noise has risen 10% from its minimum value. The power was measured using a Scientech Power-Energy Meter [6].

Testing was also performed at 690 GHz using the same mixer block with a circuit designed specifically for this frequency. Testing with the SC1T5-S5 planar diode yielded a DSB system noise temperature of 3110 K and mixer conversion loss of 9.2 dB using less than 0.6 mW of LO power. A plot of the system noise temperature versus LO power at 690 GHz is shown in Fig. 8. Currently, only two circuits have been tested, and it is expected that testing different finger length diodes with slight modifications to the circuit will improve the 690 GHz performance.

### **Cryogenic Results at 585 GHz**

The 585 GHz mixer with an SC1T5-S10 diode was tested at both 77 K and 4.2 K. The DSB receiver noise temperature in the dewar dropped from a room temperature value of 2630 K to a cooled noise temperature at 77 K of 1250 K. Further cooling to 4.2 K reduced the system noise temperature to 880 K. In addition to the improvement in system performance, the LO power requirement for the mixer dropped significantly upon cooling, as shown in Fig. 9. The best room temperature and cryogenic receiver results are summarized in Table I.

### **Comparison of Simulations with Measured Results**

The predicted mixer performance discussed previously was for a mixer with no circuit or coupling losses. The predicted losses for the 585 GHz and 690 GHz mixers at room temperature are given in Table II. The losses in the microstrip and in the planar diode chip were estimated using the 2-dimensional port solve routine in HFSS. Conductor losses are difficult to estimate for transmission lines with significant surface roughness. However, as discussed by Edwards [7], the loss for a microstrip line with a surface roughness much larger than the skin depth is approximately double that of a smooth line. The microstrip and planar diode chip conductor losses in Table II have therefore been doubled from the value predicted for a smooth

conductor. The conductor loss in the feedhorn was estimated by assuming that the feedhorn has a loss similar to that of the input waveguide, which was calculated using HFSS to be 0.05 dB/mm. For a horn length of 12 mm this yields a horn loss of 0.6 dB. The losses in the quasi-optical system consist of losses in the off-axis parabolic mirror and the Martin-Puplett diplexer. At submillimeter wavelengths, the off-axis mirror has a loss of approximately 0.22 dB, while the diplexer mirrors have losses of about 0.07 dB per reflection [8]. Each wire grid is estimated to cause 0.1 dB of loss. A signal passing through the diplexer is affected twice by the mirrors, and three times by the grids, leading to an estimate of 0.7 dB for the total quasi-optical system.

Using these estimates of the system losses, the modeling can then be compared with the measured results, and as seen in Table II the two agree to within about one dB. In general, it was found that the modeling techniques used in this research are useful for designing a mixer to near the optimum operating point, but that the final fine-tuning of the system must be performed experimentally. This fine-tuning is aided by the insight that the modeling gives into the effects of various mixer adjustments on the mixer performance. For the 585 GHz mixer, the experimental adjustments consisted of testing mixers with various diode mounting positions, various microstrip gap lengths, and diode chips with different finger lengths.

### **Conclusions**

For the first time a planar diode mixer has exhibited performance comparable to a whisker-contacted diode in this frequency range. Furthermore, it is important to note that this performance was obtained with no variable tuning elements in the mixer, in contrast to the best whisker-contacted mixers, which used tunable backshorts. Also, the planar diode used for this research was not optimized for operation at 600 GHz. By making slight changes to the mixer block and using higher doped, smaller anode diameter diodes, planar diode mixers are predicted to perform as well or better than the best whisker-contacted diode mixers in this frequency range.

In summary, this research has demonstrated that through the use of modern high frequency simulation tools, it is now possible to design and fabricate optimized submillimeter wavelength mixers based on planar diodes. Furthermore, these mixers can be quite broadband without the need for adjustable tuners. Future research will lead to improved mixer performance and greater operating frequency. These new mixers are expected to completely replace whisker-contacted mixers at most submillimeter wavelengths, thus providing a simple, rugged, room temperature receiver technology with excellent sensitivity.

### Acknowledgments

The authors would like to acknowledge the assistance of William L. Bishop and Frank Li in the fabrication of the diodes used in this research and Hewlett Packard for the donation of their High Frequency Design System software to the University of Virginia. This research has been supported by the U.S. Army National Ground Intelligence Center through contract DAHC90-91-C-0030 and the U.S. Army Research Office through AASERT grant DAAL03-92-G-0057.

### References

1. R. Zimmermann, R. Zimmermann, and P. Zimmermann, "All Solid-State Radiometers for Environmental Studies to 700 GHz," Third Int. Sym. Space THz Tech., Ann Arbor, MI, March 1992.
2. W.L. Bishop, K. McKinney, R.J. Mattauch, T.W. Crowe and G. Green, "A novel whiskerless diode for millimeter and submillimeter wave applications," 1987 IEEE MTT-S Int. Mic. Sym. Digest, pp. 607-610, June 1987.
3. W.L. Bishop, E. Meiburg, R.J. Mattauch, T.W. Crowe and L. Poli, "A  $\mu\text{m}$ -thickness, planar Schottky diode chip for terahertz applications with theoretical minimum parasitic capacitance," 1990 IEEE MTT-S Int. Mic. Sym. Digest, pp. 1305-1308, May 1990.
4. J. Johansson and N.D. Whyborn, "The diagonal horn as a sub-millimeter wave antenna" IEEE MTT, pp. 795-800, May 1992.
5. D.H. Martin and E. Puplett, "Polarised interferometric spectrometry for the millimetre and submillimetre spectrum," *Infrared Phys.* **10**, pp. 105-109, 1966.
6. Scientech Model 365, Scientech, Inc., 5649 Arapahoe Ave., Boulder, CO 80303.
7. T.C. Edwards, *Foundations for Microstrip Circuit Design*, New York, John Wiley & Sons, 1985.
8. JML Direct Optics, 690 Portland Ave., Rochester, NY 14621.

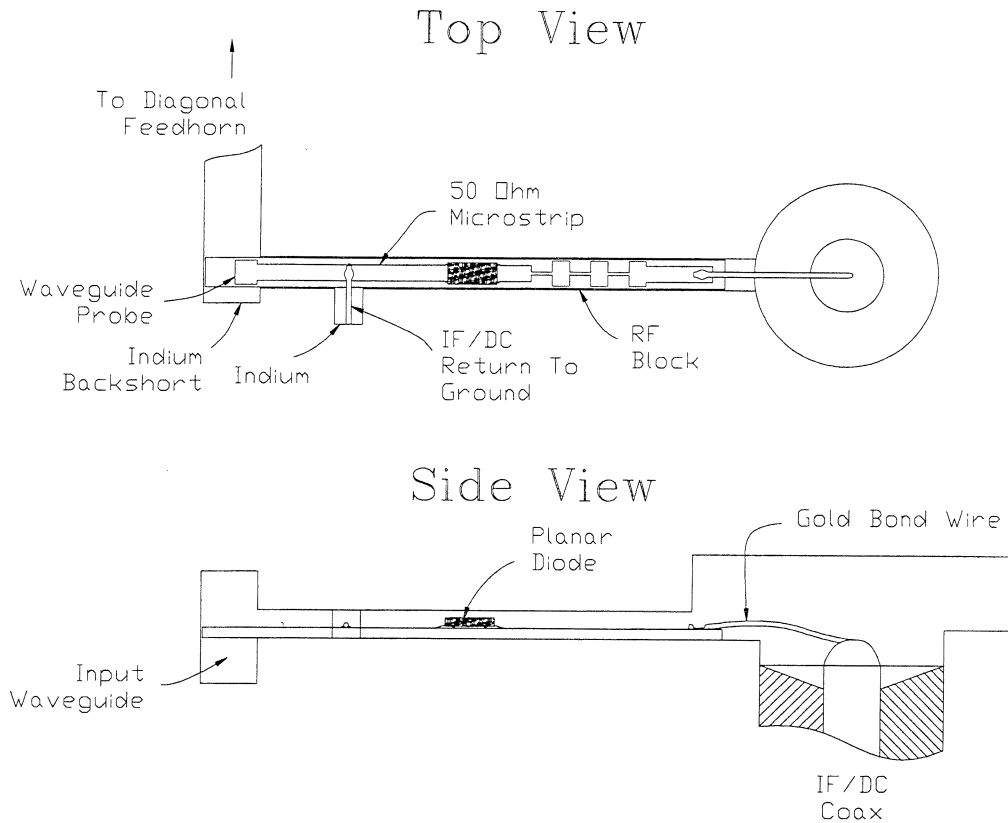

Fig. 1. Schematic of the interior of the mixer block, showing the quartz circuit and diode chip mounted in the block.

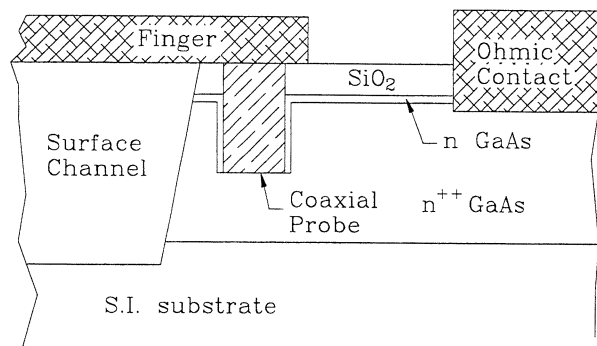

Fig. 2. Schematic of the planar diode chip near the anode with a coaxial probe inserted near the anode. This was used during the finite element modeling to determine the diode embedding impedance.

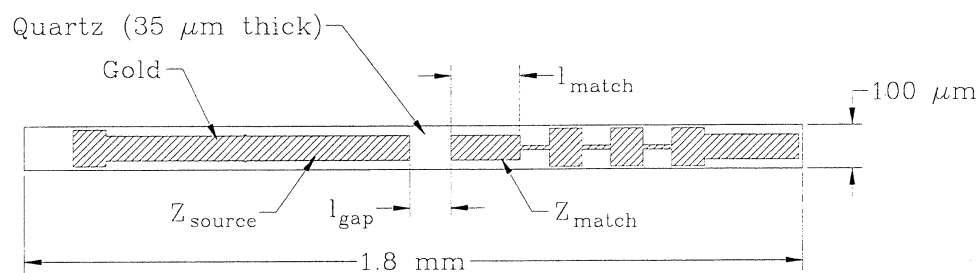

Fig. 3. Schematic of the basic mixer circuit configuration used during this research.

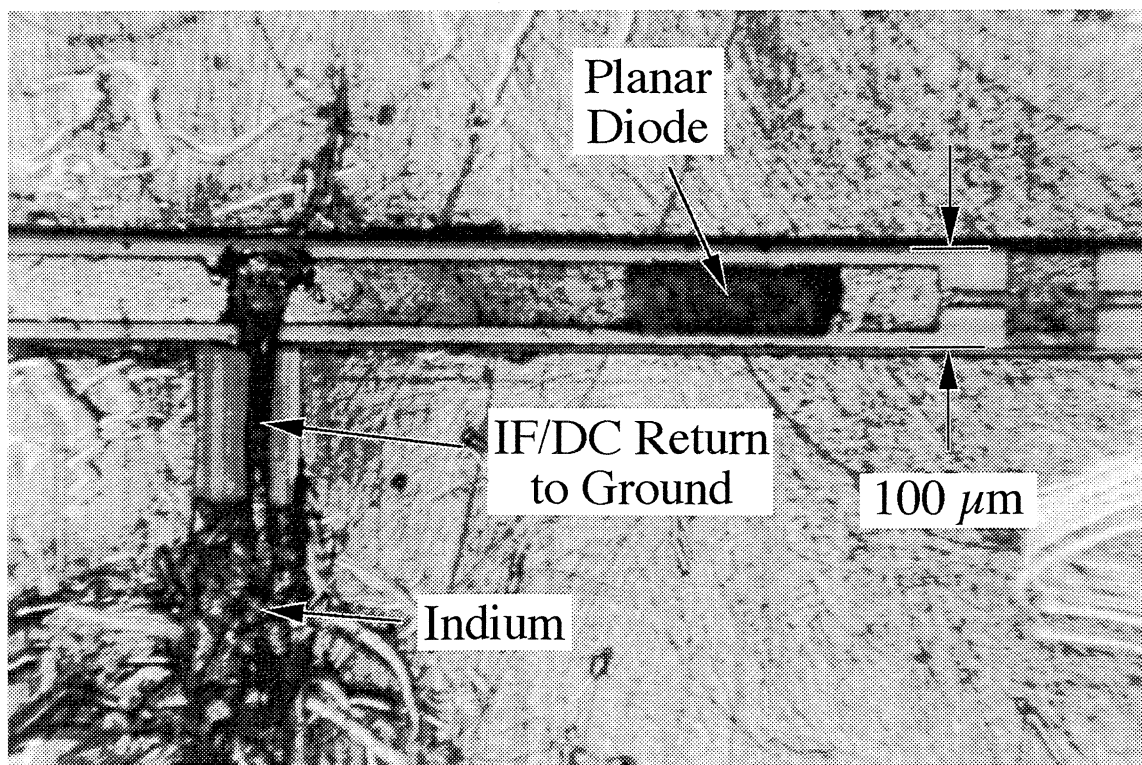

Fig. 4. Picture of the microstrip circuit mounted in mixer block.



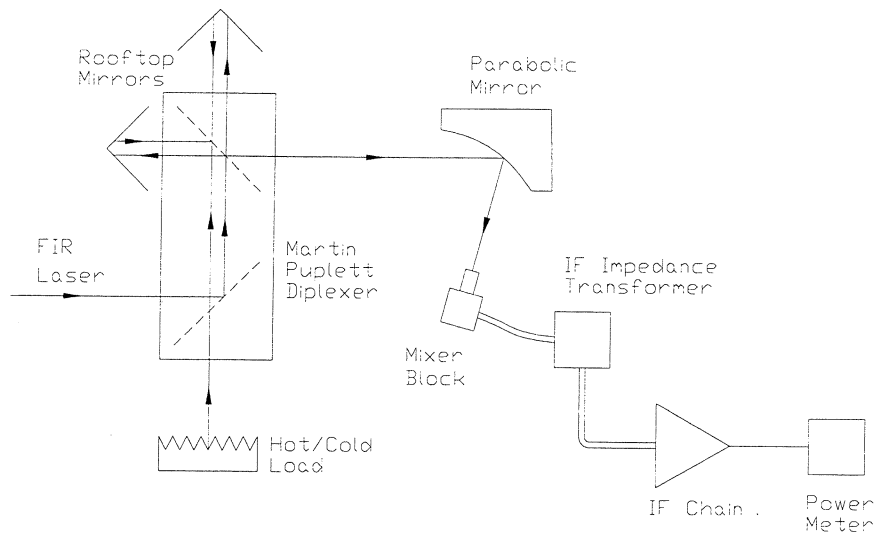

Fig. 5. Schematic of the receiver measurement setup used during this research.

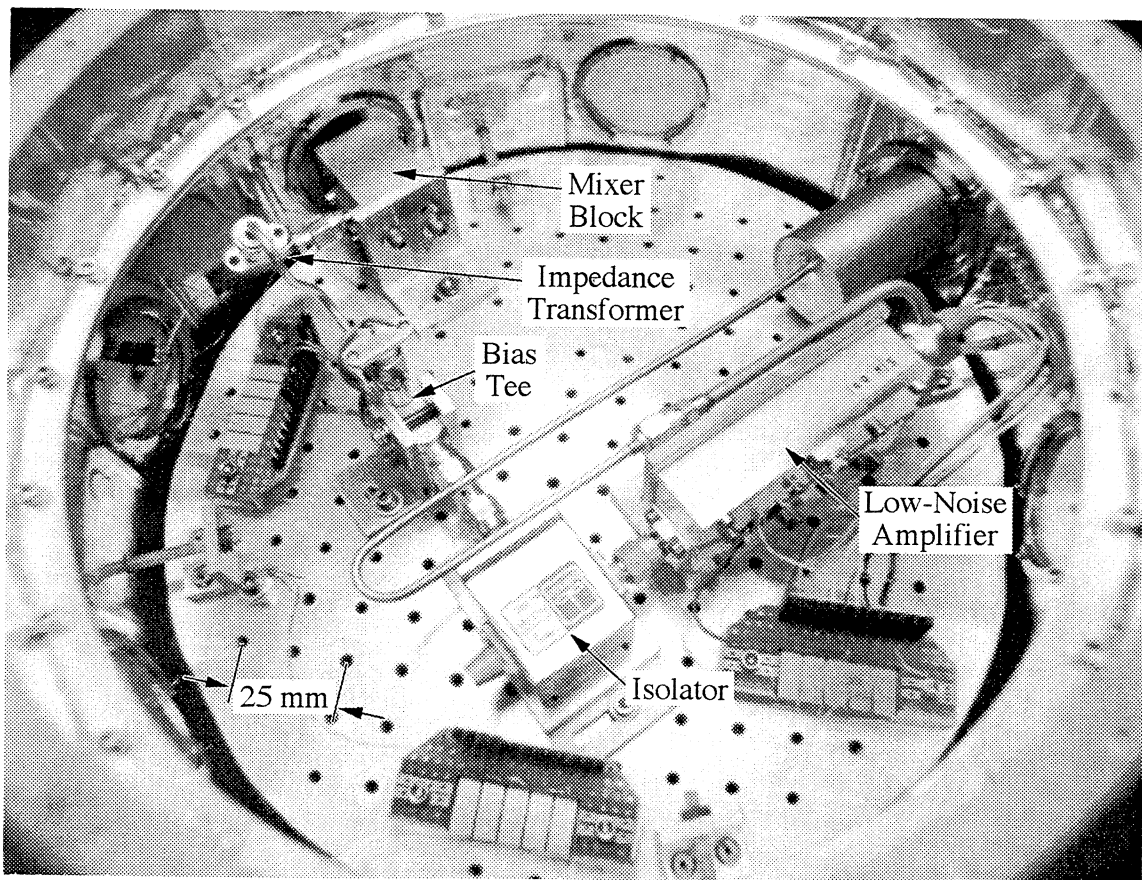

Fig. 6. Picture of the Infrared Laboratories HD-3(8) dewar used during the mixer testing at 77 K and 4.2 K.

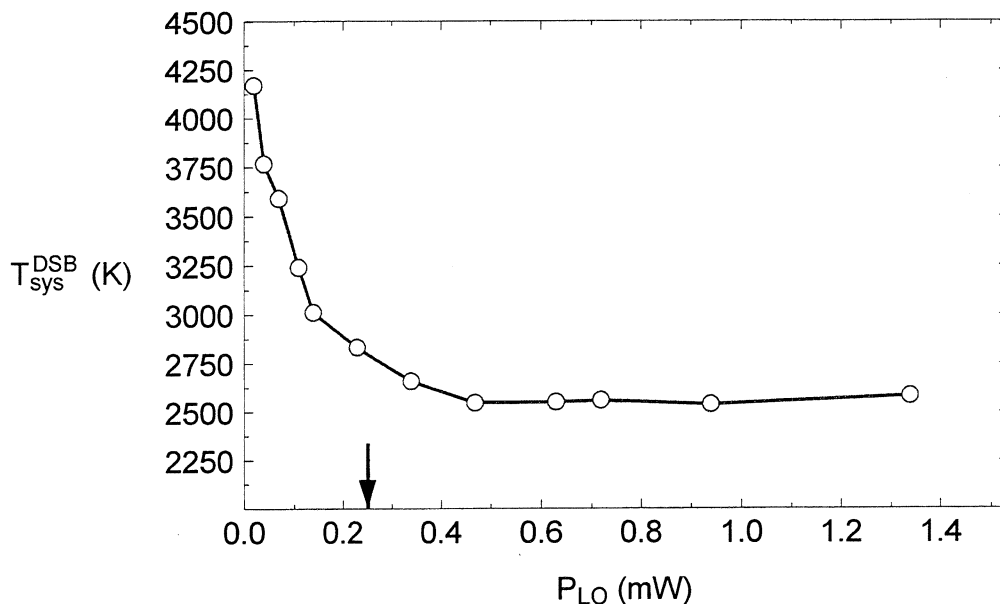

Fig. 7. 585 GHz receiver results using the UVa SC1T5-S10 planar diode at room temperature. The arrow indicates the power at which the system noise temperature has risen by 10% from its minimum value.

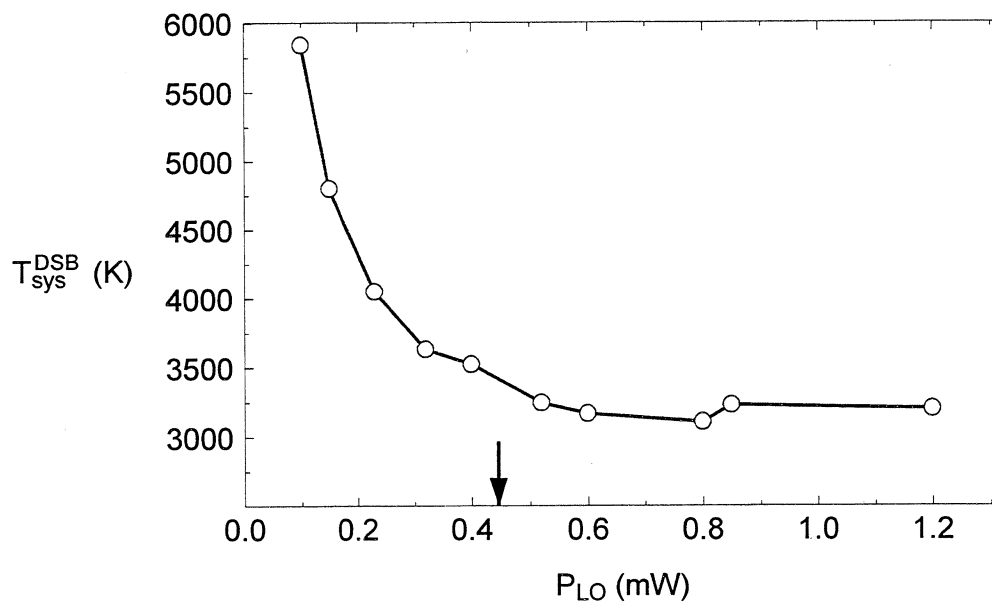

Fig. 8. 690 GHz receiver results using the UVa SC1T5-S5 planar diode at room temperature. The arrow indicates the power at which the system noise temperature has risen by 10% from its minimum value.

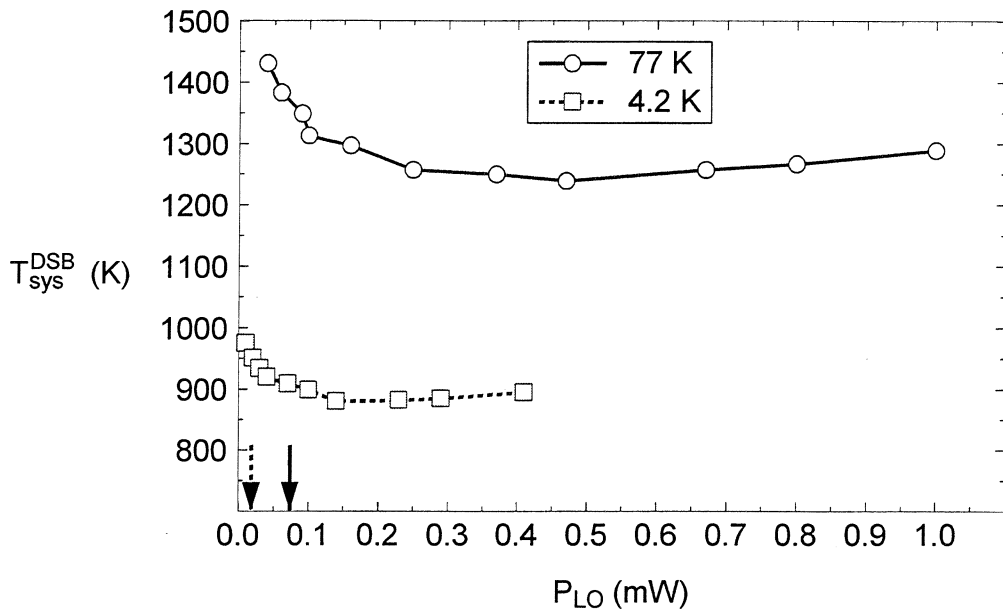

Fig. 9. 585 GHz results for the UVa SC1T5-S10 planar diode at 77 K and 4.2 K. The arrows indicate the power at which the system noise temperature has risen by 10% from its minimum value.

TABLE I  
Summary of Receiver Test Results at 585 and 690 GHz for the SC1T5 planar Schottky diode

$\nu_{RF}$ (GHz)	Temp. (K)	$T_{sys}^{DSB}$ (K)	$T_{mix}^{DSB}$ (K)	$L^{DSB}$ (dB)
585	300	2380	1800	7.6
585	77	1250	1110	9.0
585	4.2	880	840	9.0
690	300	3110	2380	9.2

TABLE II  
 Comparison of the measured results with the modeled results, including estimated system losses.

	585 GHz	690 GHz
<b><u>Modeled</u></b>		
$L_{HB}^{DSB}$ (no loss) (dB)	3.8	5.5
Microstrip Losses (dB)	1.0	1.0
Losses in Diode Chip (dB)	0.7	0.7
Horn Losses (dB)	0.6	0.6
Diplexer and Mirror Losses (dB)	0.7	0.7
$L_{HB}^{DSB}$ (with loss) (dB)	6.8	8.5
<b><u>Measured</u></b>		
$L^{DSB}$ (dB)	7.6	9.2