

## The Dielectric-Filled Parabola: Concept and Applications Review

*Peter H. Siegel, Robert Dengler, Moonil Kim and Philip Stimson*

California Institute of Technology Jet Propulsion Laboratory

4800 Oak Grove Drive

Pasadena, California 91109

The dielectric-filled parabola [1] is a thick-substrate-lens-antenna implementation based on the pioneering work of Rutledge et. al. [e.g. 2]. It was conceived [3] as a simple means of creating a large f-number beam from a photolithographically fabricated antenna or modest planar array. In implementation, it consists of a plano-convex dielectric lens whose curved surface takes the shape of a parabola ( $y^2=4fx$ ) and whose flat surface resides at the focal point of the lens. In operation, the parabolic surface is metallized and the receiving or transmitting antenna and associated solid-state driving circuitry are mounted on a separate dielectric wafer which lies in intimate contact with the flat surface. Illumination takes place from the front (flat side) and, as in the case of [4], through a small hole left in the metal at the center of the curved surface. The structure has several features which make it advantageous for use at millimeter and submillimeter wavelengths including inherently high f-number, simple-to-apply matching layers, reasonable dielectric path length, reduced off-axis aberration (compared to an unfilled parabolic mirror) etc.

Since its original conception, the dielectric-filled parabola has been used successfully to demonstrate the first millimeter-wave superconducting planar heterodyne array [5], an all-planar millimeter/submillimeter-wave fundamental Schottky diode mixer [6] and recently a novel quad-bridge multiplier concept [7]. These applications will be reviewed and several interesting design improvements/modifications will be considered.

---

[1]. P.H. Siegel and R.J. Dengler, "The Dielectric-Filled Parabola: A New Millimeter/Submillimeter Wavelength Receiver/Transmitter Front End," *IEEE Trans. Antennas and Propagation*, vol. 39, no. 1, pp. 40-48, Jan. 1991.

[2]. D.B. Rutledge, D.P. Neikirk and D.P. Kasilingam, "Integrated Circuit Antennas," in *Infrared and Millimeter Waves*, vol. 10., New York: Academic Press, 1983, pp. 1-90.

[3]. P.H. Siegel, "Dielectric Filled Parabola with Integrated Planar Antenna for use as a Millimeter/Submillimeter Wavelength Receiver/Transmitter Front End," *JPL New Technology Report 17802/7300*, Feb. 1989.

[4]. P.H. Siegel, "A Submillimeter-Wave Heterodyne Array Receiver Using a Dielectric-Filled Parabola: Concept and Design," *1st International Symposium on Space THz Technology*, pp. 218-234, Mar. 5-6, 1990

[5]. P.A. Stimson, R.J. Dengler, H.G. LeDuc and P.H. Siegel, "Superconducting Heterodyne Planar Array Mixer Using a Dielectric-Filled Parabola: Status and Measured Performance," *Multi-Feed Systems for Radio Telescopes*, Tucson, AZ, May 16-17, 1994

[6]. P.H. Siegel, "An Open-Structure Mixer Using an All-GaAs Integrated Diode/Antenna Wafer for Millimeter and Submillimeter Wavelengths," *JPL New Technology Report*, NPO-19371/8972, January, 1994.

[7]. M. Kim, J. Bruston, R.P. Smith, S.C. Martin and P.H. Siegel, "A Slot-Antenna Bridge-Frequency Multiplier Design Suitable for Submillimeter Wavelengths," *Submitted to 1996 IEEE AP-S International Symposium on Antennas and Propagation*, January 1996.

## **The Dielectric-Filled Parabola: Concept and Applications Review**

*Peter H. Siegel, Robert Dengler, Moonil Kim, Phil Stimson*

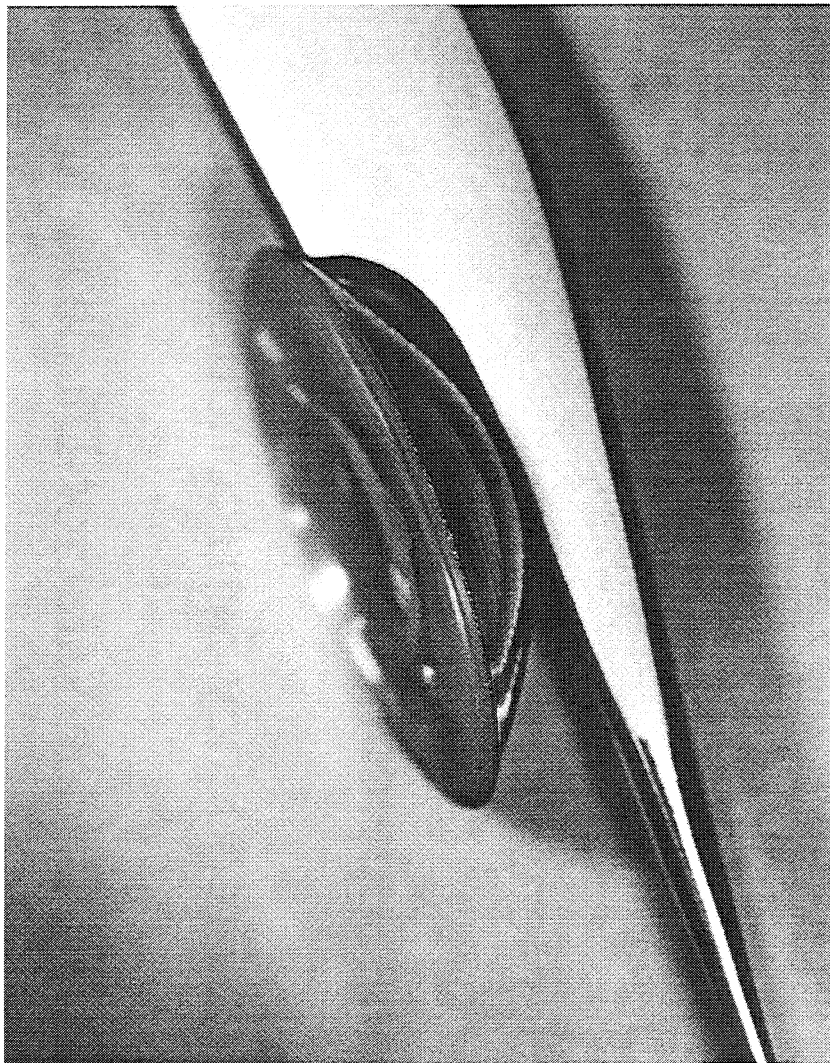

California Institute of Technology  
Jet Propulsion Laboratory  
Pasadena, California

Seventh International Symposium on Space THz Technology  
March 12-14, 1996

## **Talk Outline**

---

1. Dielectric-Filled Parabola: Concept
2. Dielectric-Filled Parabola: Properties
3. Dielectric-Filled Parabola: Applications
  - a. Single Element Planar Antenna Receiver/Transmitter
  - b. Multibeam Superconducting Planar Array
  - c. Ultra-High Frequency Semiconductor-Diode Mixer
  - d. Planar Quad-Bridge Varactor-Diode Multiplier

# Problems with Planar Antenna Structures at High Frequencies

Substrate Modes

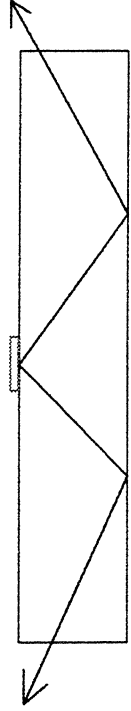

Low Directivity

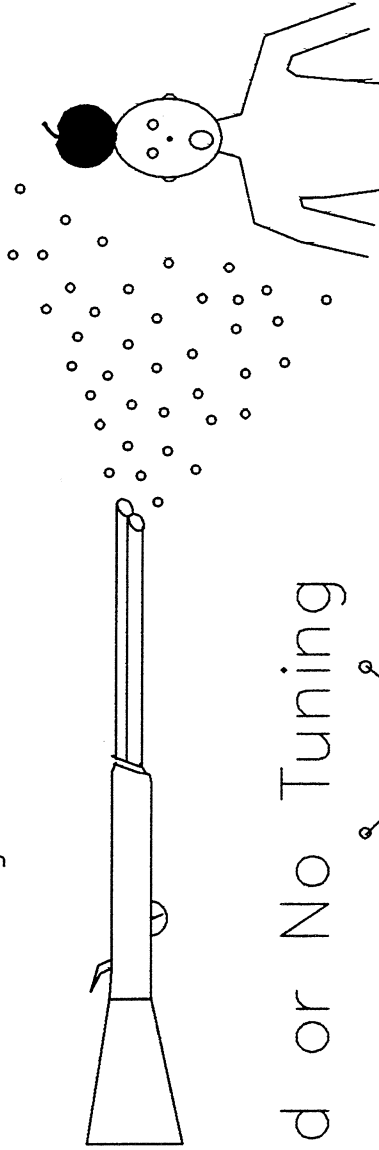

Limited or No Tuning

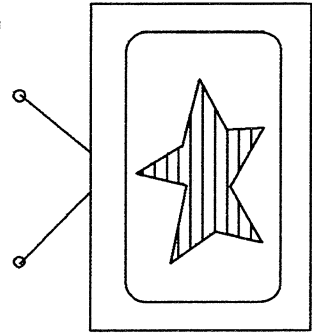

# Conceptual Schematic of the Dielectric-Filled Parabola Used in a Heterodyne Receiver Configuration

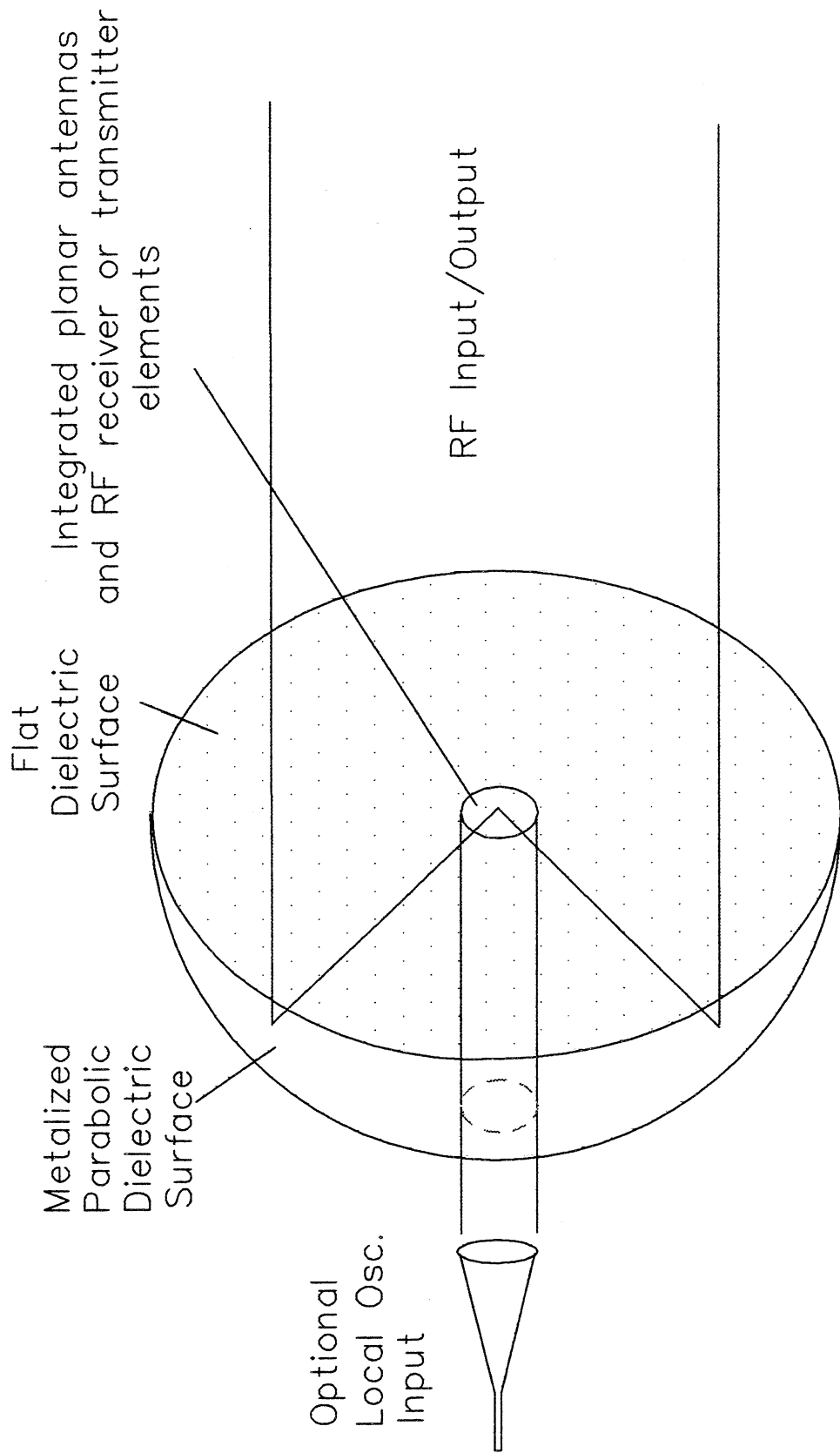

## **Dielectric-Filled Parabola: Advantages**

---

- Conceived as a potential solution to a variety of high freq. planar antenna problems
- Combines the thick substrate lens concept of Rutledge et. al. with the high directivity inherent in parabolic reflectors
- Converts low-directivity half-wave resonant planar antennas to high f-number output beam with a single low-loss low-dielectric-constant lens
- Maintains a flat input/output plane for simple incorporation of substrate wafers, matching layers, or corrective optics
- Relatively insensitive to lateral and axial defocusing
- Modest beam steering capability with predictable coma lobe for off-axis elements
- Slightly shorter dielectric path length than hyperhemisphere or elliptical lenses
- Cassegrain style LO injection capability
- Suitable for room temperature or cryogenic operation

## Dielectric-Filled Parabola: Disadvantages

---

- Limited focal plane filling due to potential beam blockage
- Susceptible to internal standing waves unless properly matched to incoming radiation
- Beam diameter (f-number) varies with frequency (lens diameter in wavelengths)
- Low  $f/D$  results in rapid rise of coma lobe for large off-axial displacements

## Dielectric-Filled Parabola: Single Element Properties

(P.H. Siegel, R.J. Dengler)

---

- Measured a variety of planar antenna elements: slots, dipoles, log-periodic, log-spiral on microwave scale model to determine beam properties and input impedances for quartz dielectric-filled parabola
- Compared probed field measurements of thick center-fed dipole with calculated results based on infinitely thin antenna and infinitely thick quartz substrate - resonant length in good agreement with predictions by Alexopoulos
- Designed and implemented appropriate IF/DC feed structures for dipoles/slots for use in mixer applications



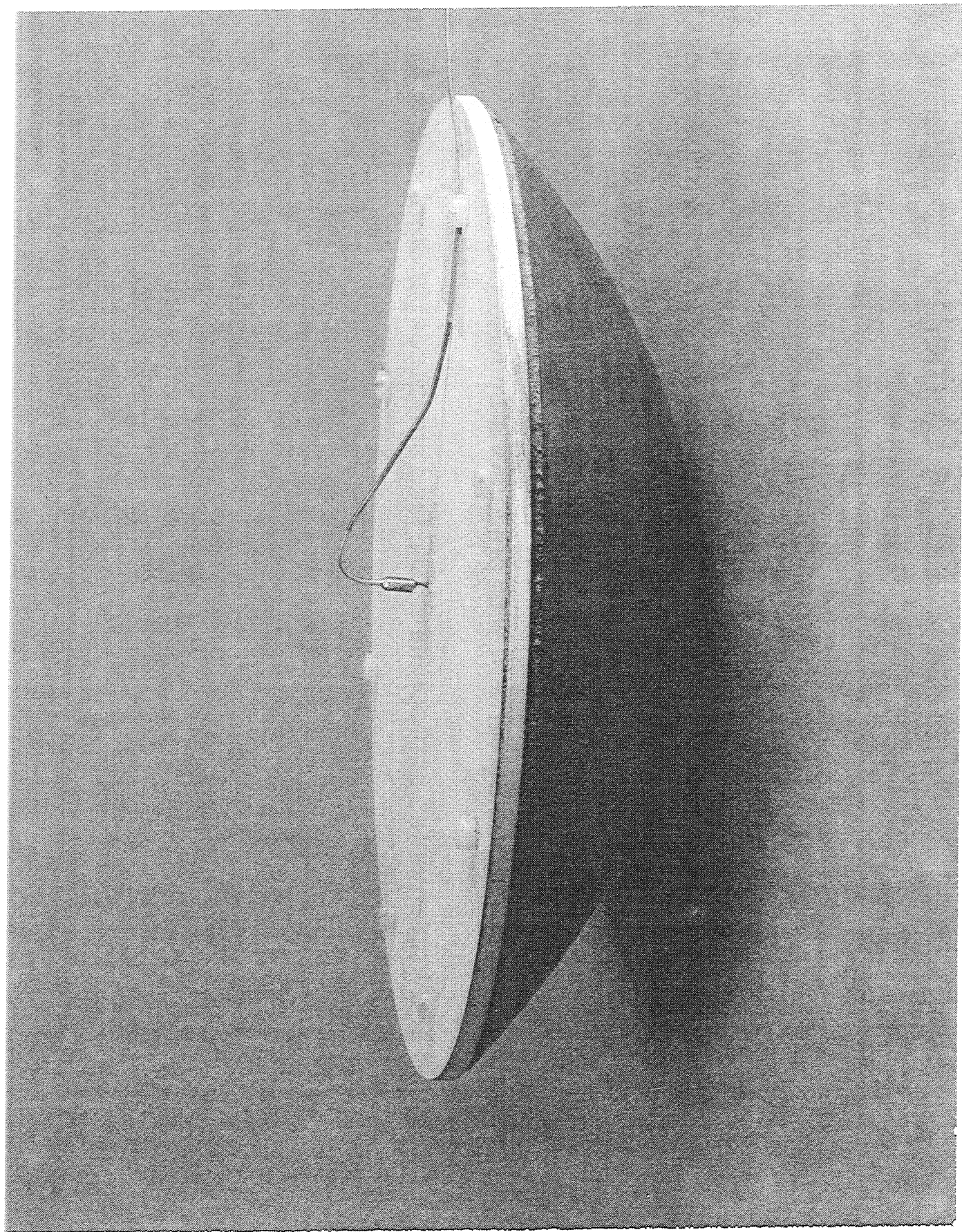

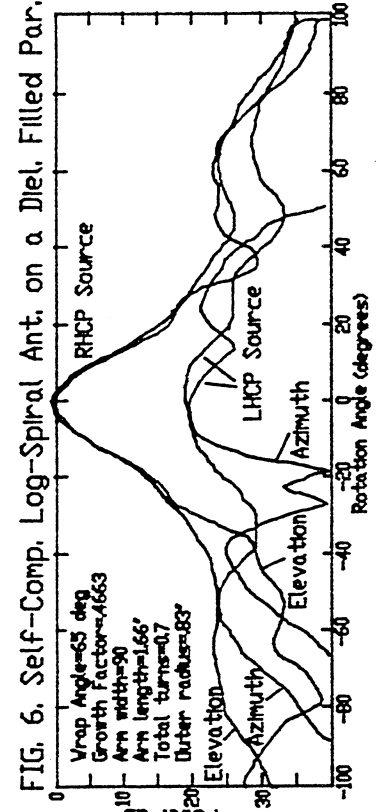
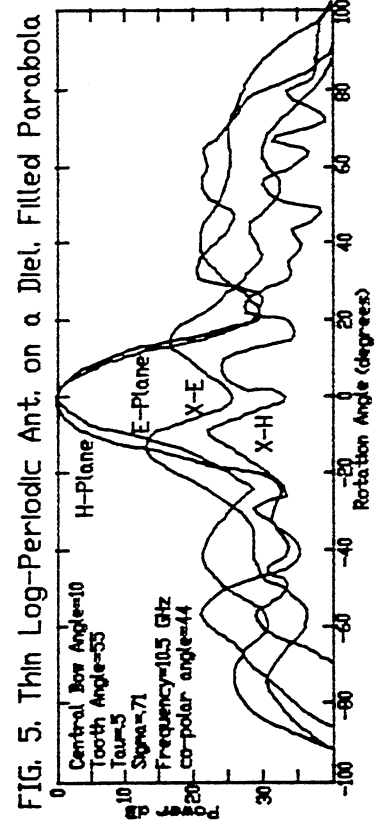
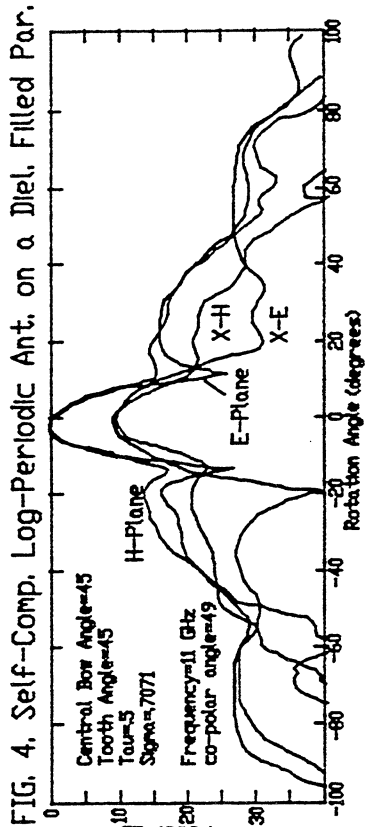
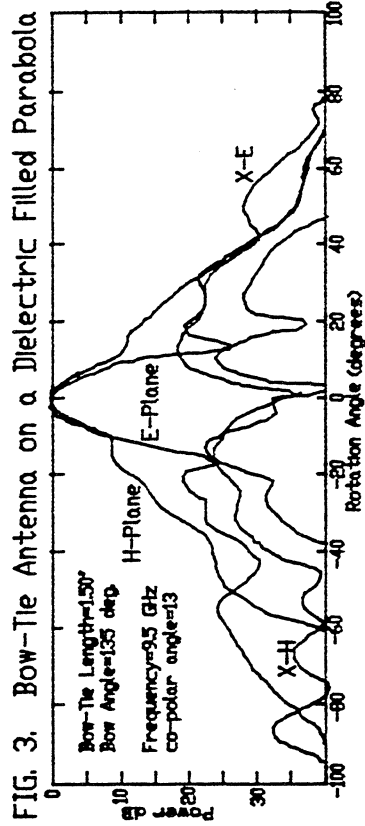
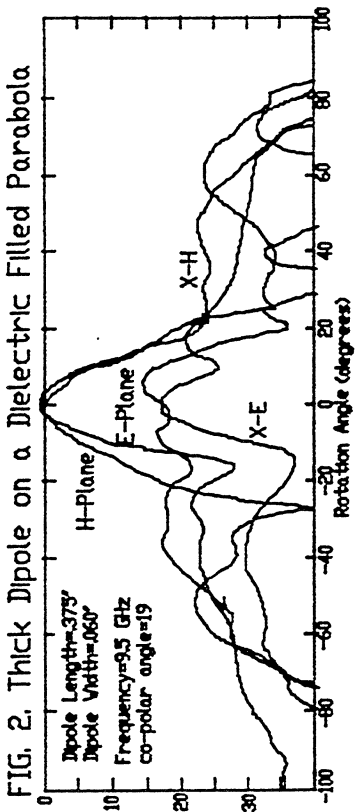
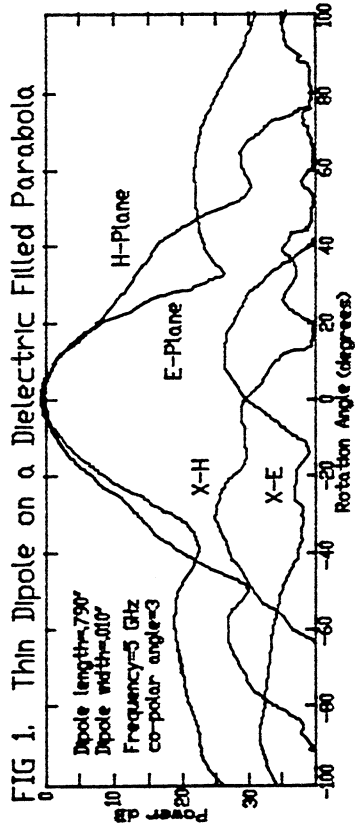

**THIN DIPOLE ON A DIELECTRIC-FILLED PARABOLA**  
 FREQ. = 4-6 GHz

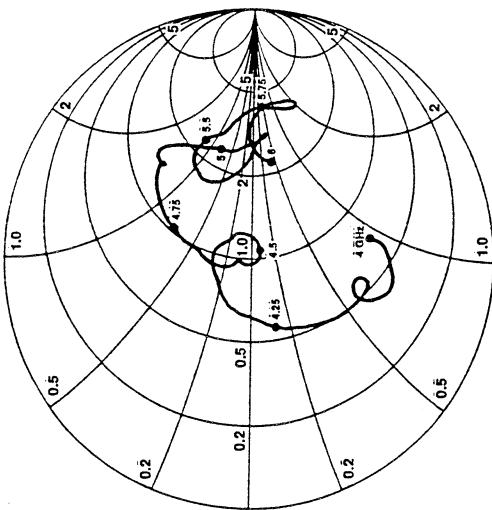

**THICK DIPOLE ON A DIELECTRIC-FILLED PARABOLA**  
 FREQ. = 8-12 GHz

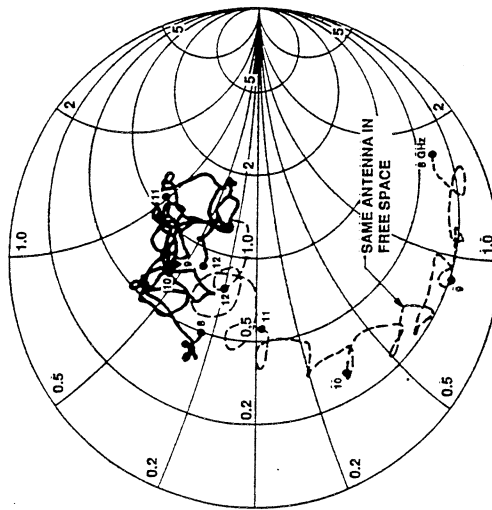

**BOW-TIE ANTENNA ON A DIELECTRIC-FILLED PARABOLA**  
 FREQ. = 8-12 GHz

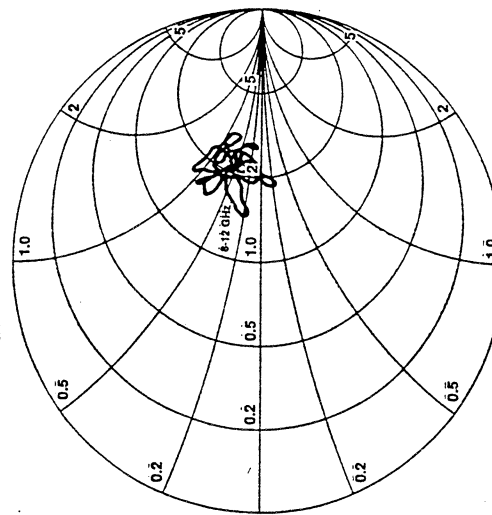

**SELF-COMP. AND THINNED LOG-PER. ANTENNA ON A DIELECTRIC-FILLED PARABOLA**  
 FREQ. = 4-12 GHz

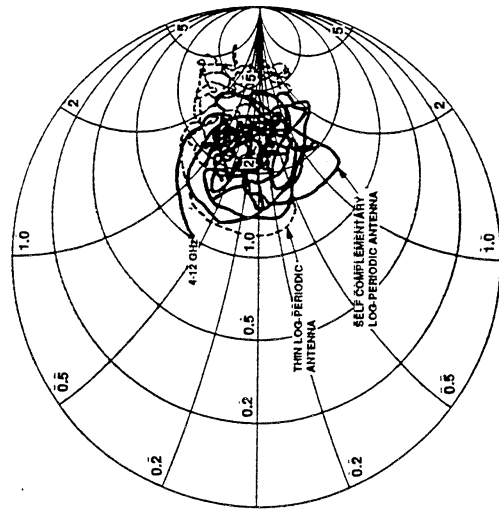

**LOG-SPIRAL ANTENNA ON A DIELECTRIC-FILLED PARABOLA**  
 FREQ. = 4-12 GHz

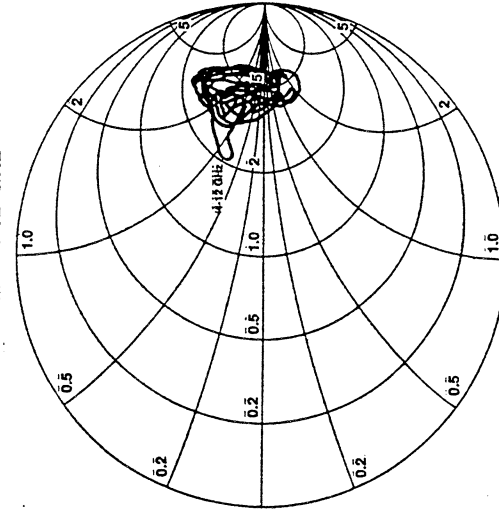

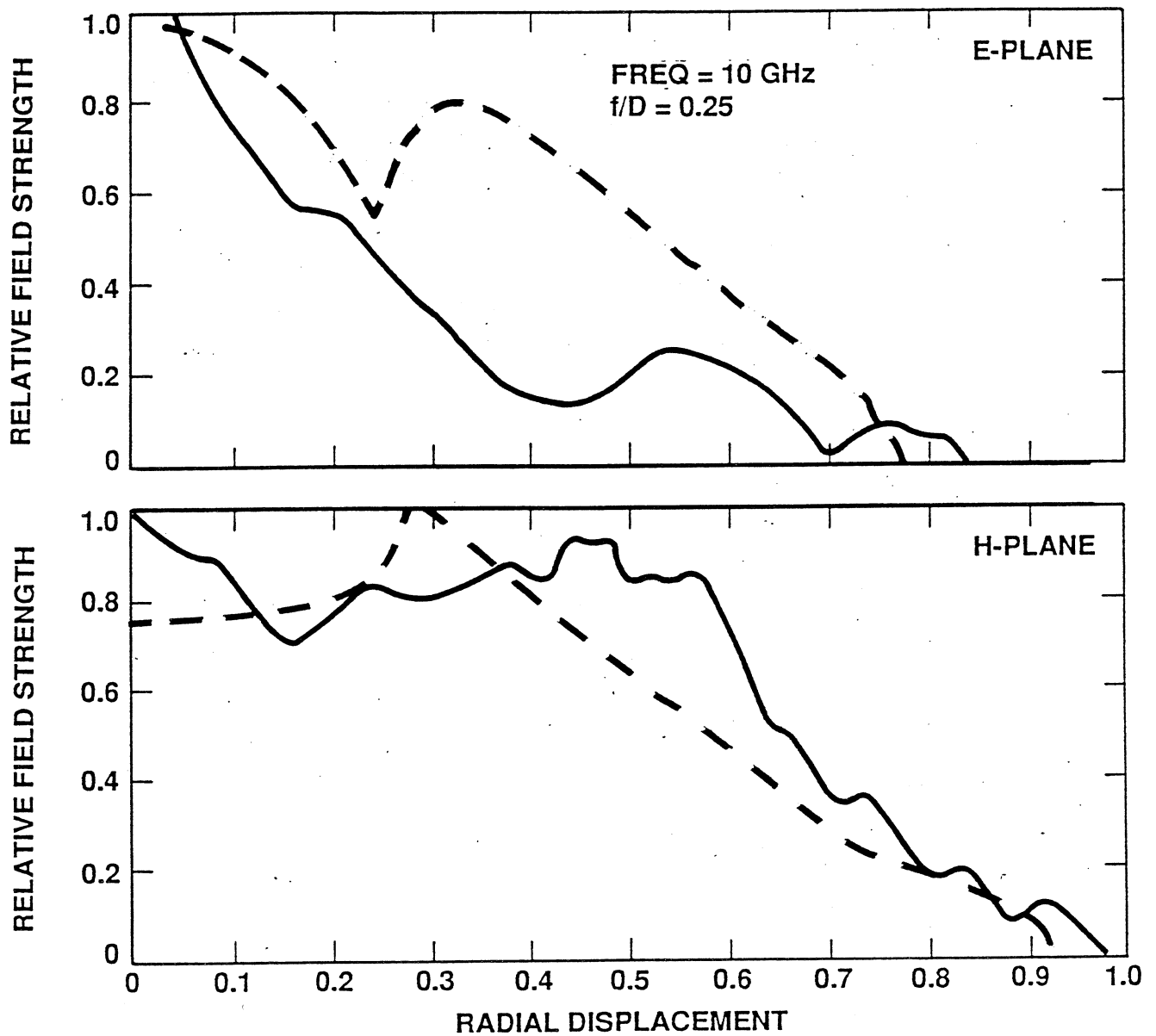
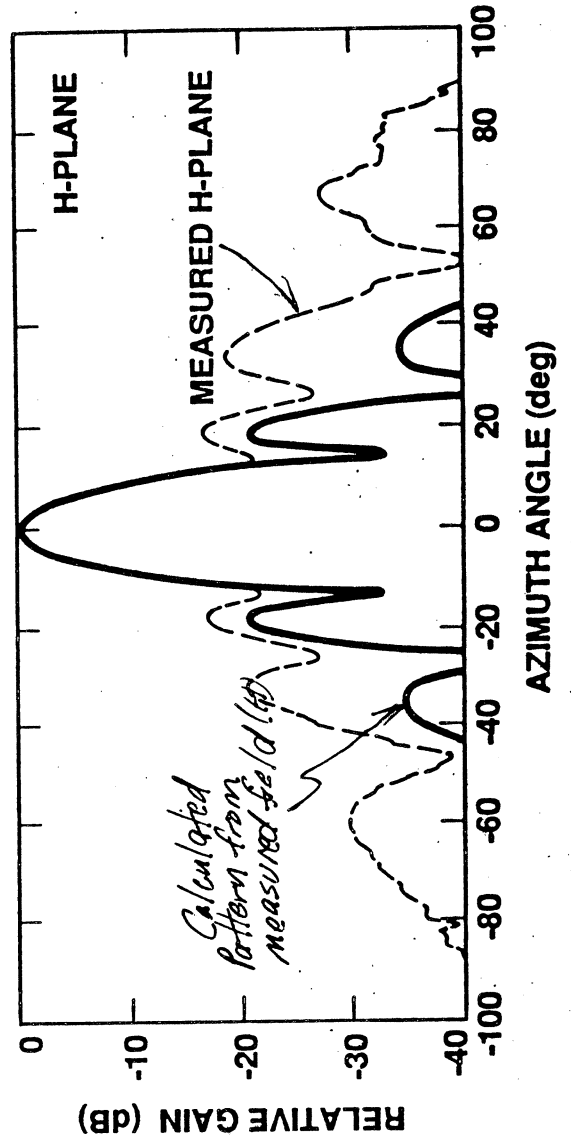
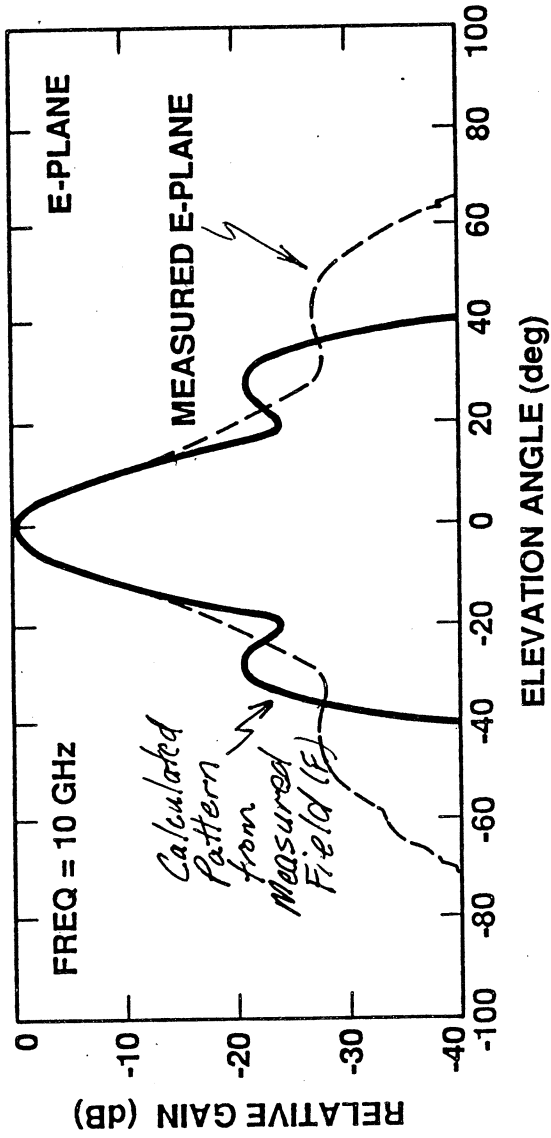

Fig. 4: A comparison of the calculated (dashed) and measured (solid) field strength along the surface of a dielectric-filled parabola with a thin dipole antenna at the focal point at 10 GHz. The calculations are based on data published in [19]. The measurements were made with a dipole probe placed in intimate contact with the lens surface. The excessive ripple is due to reflections off the air-dielectric interface.

# CALCULATED POWER PATTERN USING MEASURED FIELDS



## Dielectric-Filled Parabola: Array Properties

(P.A. Stimson, R.J. Dengler, P.H. Siegel, H.G. LeDuc)

---

- Modeled array beam properties of dipoles on quartz in 2X5 arrangement
- Off-axis beam placement and RF/IF filtering empirically determined through measurements
- Implemented first array at 200 GHz in submersion dewar at 4K with niobium SIS tunnel junctions from LeDuc and Bumble - 10 working elements - DSB noise performance between 75K and 250K with fixed LO
- UMichigan developed first complete analysis of DFP structure with predictions of on/off-axis performance using slots and dipoles (Filipovic, Ali-Ahmad, Raman, Gautier, Rebeiz)
- University of Koeln (Bischoff, Jacobs) developed slot array on silicon DFP structure and performed extensive analysis of off-axis beam patterns and impedance matching. Currently working on 490 GHz implementation.
- Corrected array optics concept (Schmidt system) designed but never implemented

# Planar Array Receiver

## Exploded Schematic

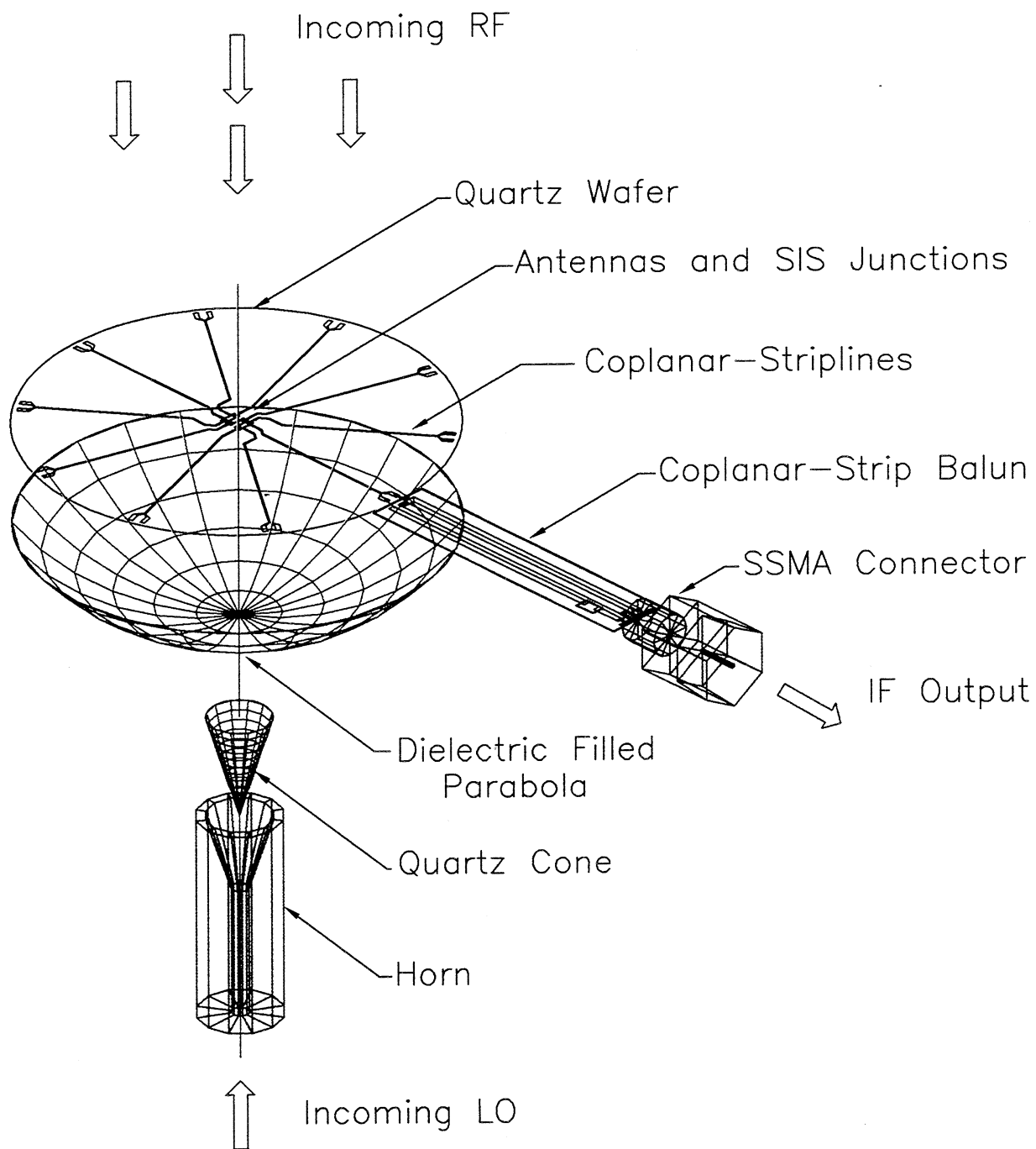

# DIPOLE/DFP PATTERNS 19-21 GHZ

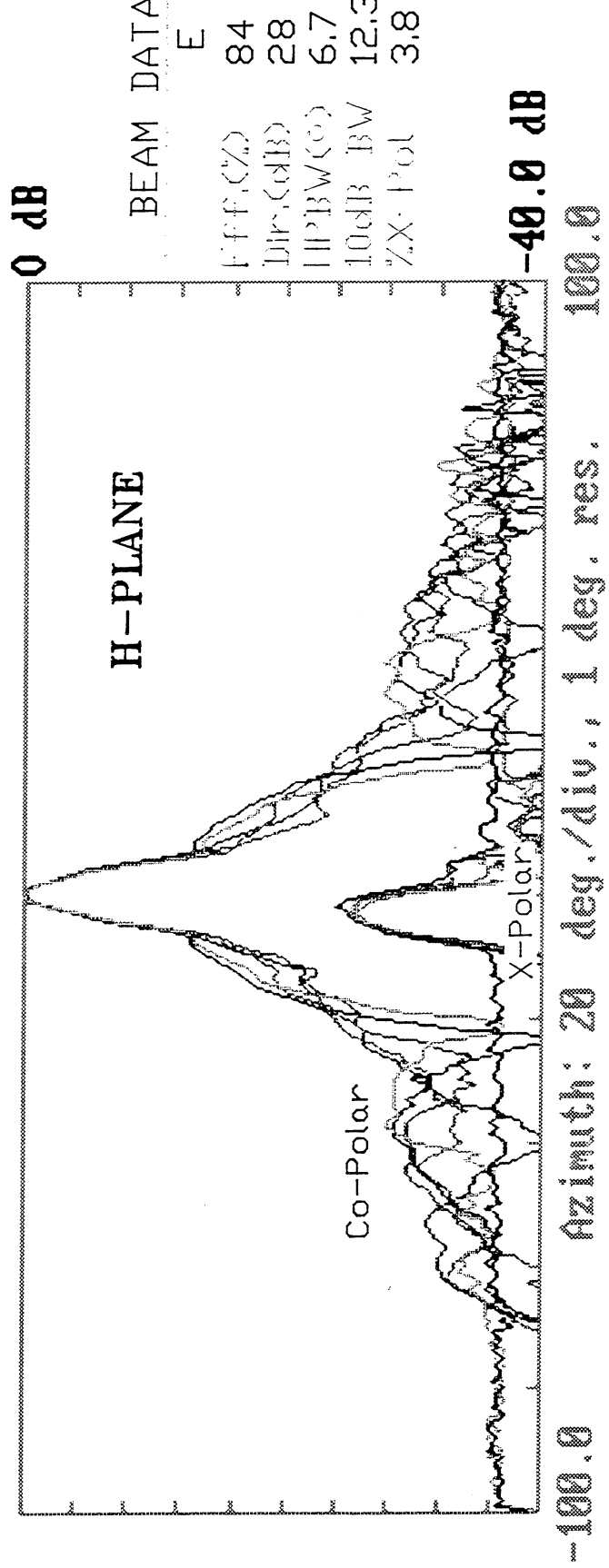
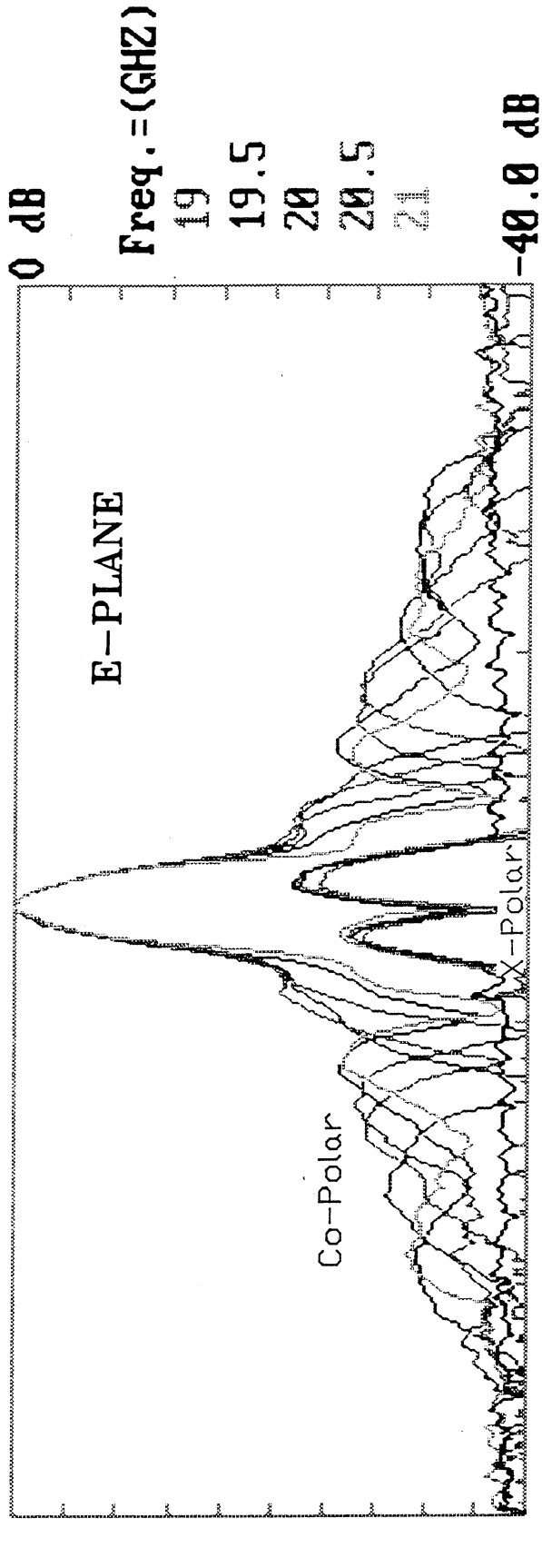

BEAM DATA

	E	H
EFF (%)	84	87
DIR (dB)	28	28
HPBW (°)	6.7	5.9
10dB BW	12.3	11.2
%X-Pol	3.8	3.0



# DIPOLE/DFP ARRAY PATTERNS AT 20GHZ

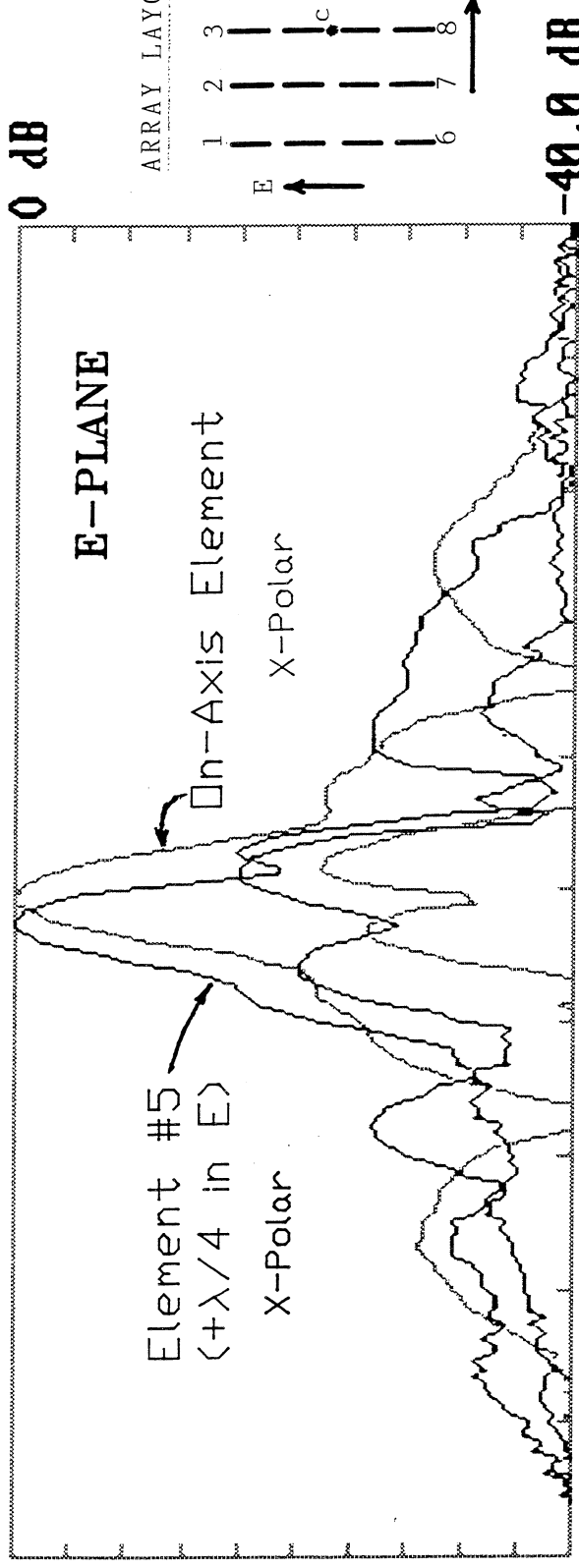

-90.0 Elevation: 18 deg./div., 1 deg. res. 90.0

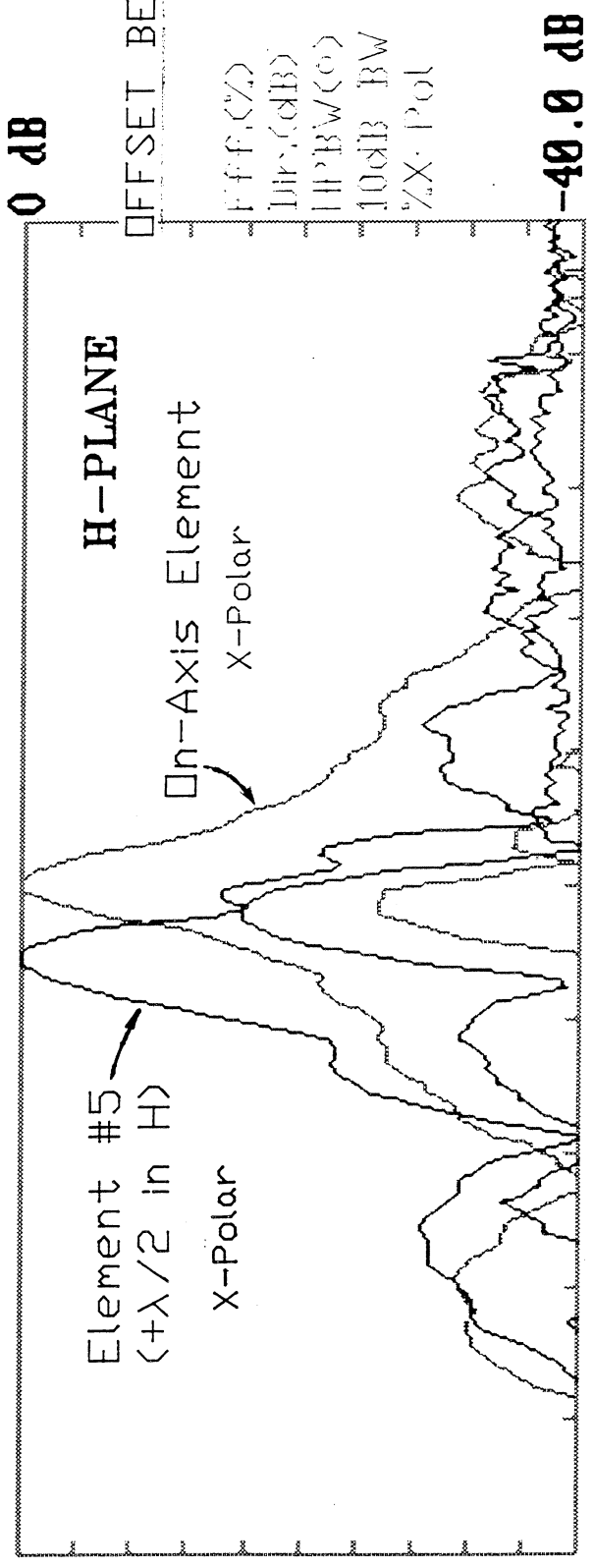

-90.0 Azimuth: 18 deg./div., 1 deg. res. 90.0

ARRAY LAYOUT

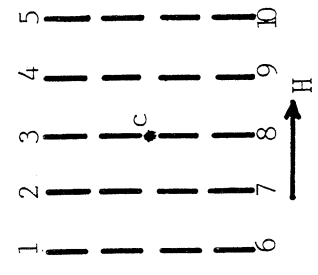

OFFSET BEAM DATA

	E	H
Eff.(%)	68	69
Dir.(dB)	28	28
HPBW( $^{\circ}$ )	6.1	6.4
10dB BW	10.9	11.5
%X-Pol	14	10.1

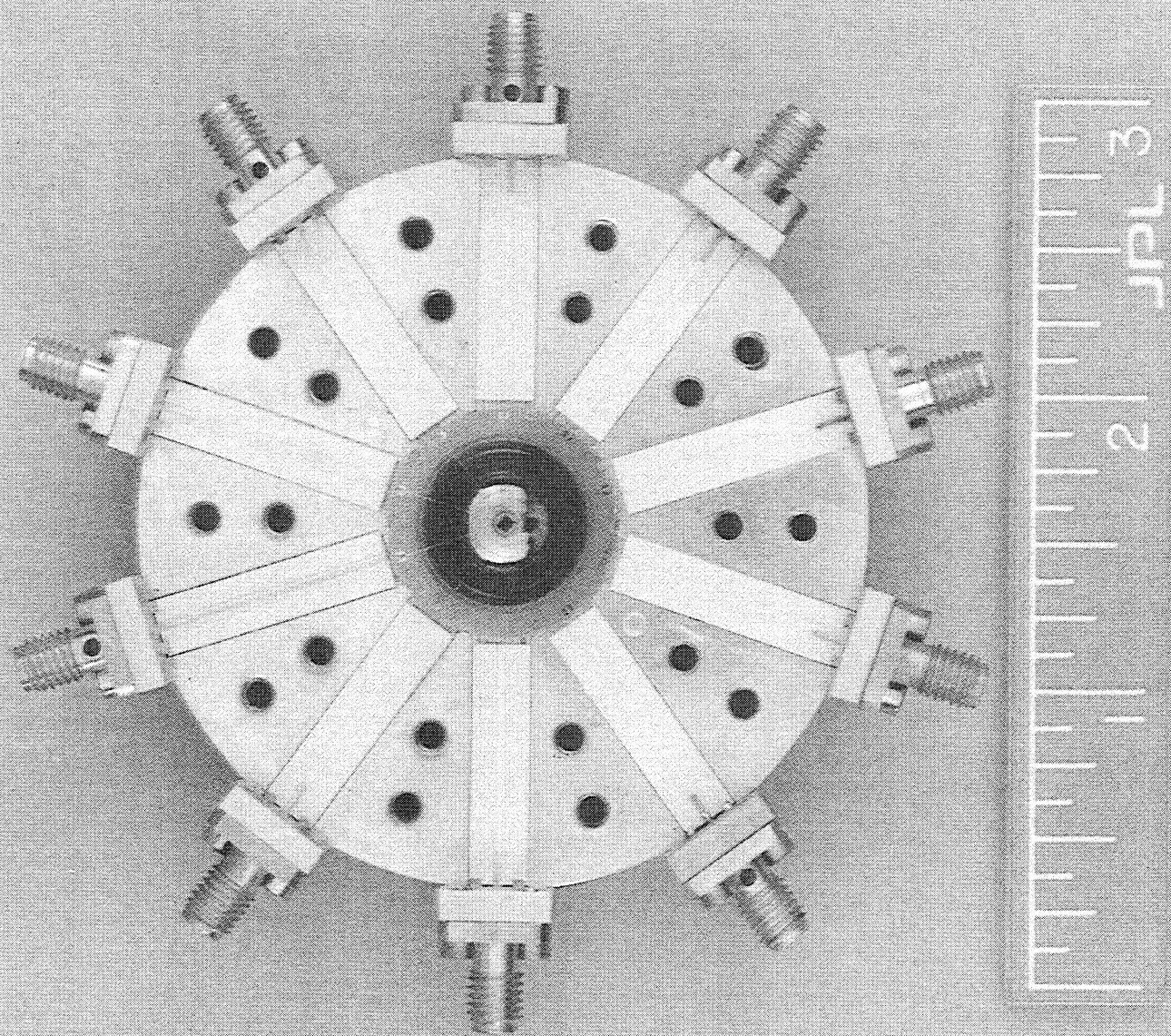

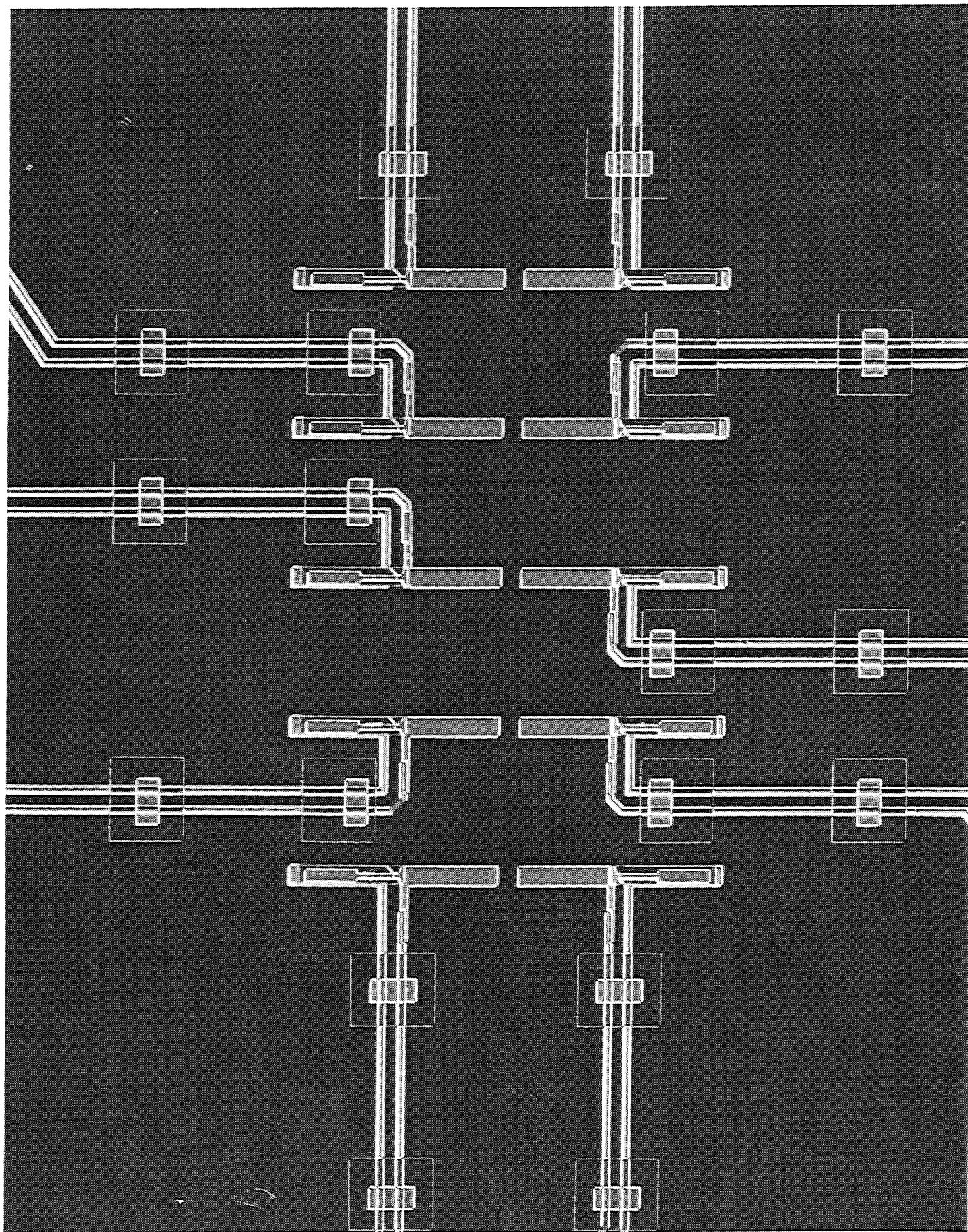

# JUNCTION UNIFORMITY

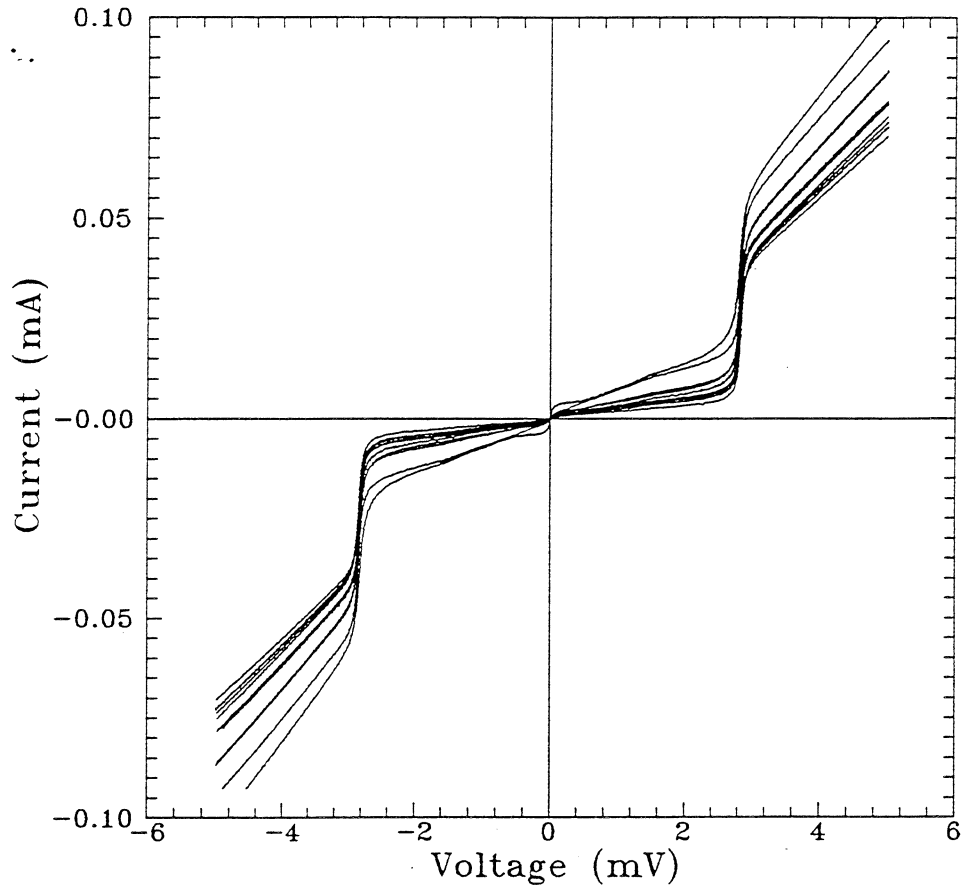

Element	$R_n$	$I_{leak}$
1	87 $\Omega$	6 $\mu A$
2	86 $\Omega$	8 $\mu A$
3	71 $\Omega$	16 $\mu A$
4	57 $\Omega$	19 $\mu A$
5	81 $\Omega$	4 $\mu A$
6	86 $\Omega$	6 $\mu A$
7	74 $\Omega$	9 $\mu A$
8	90 $\Omega$	7 $\mu A$
9	75 $\Omega$	10 $\mu A$
10	81 $\Omega$	7 $\mu A$

Elt. Rank
5
6
1
10
8
2
7
9
3
4

# Mixer Noise Temperature at Fixed LO

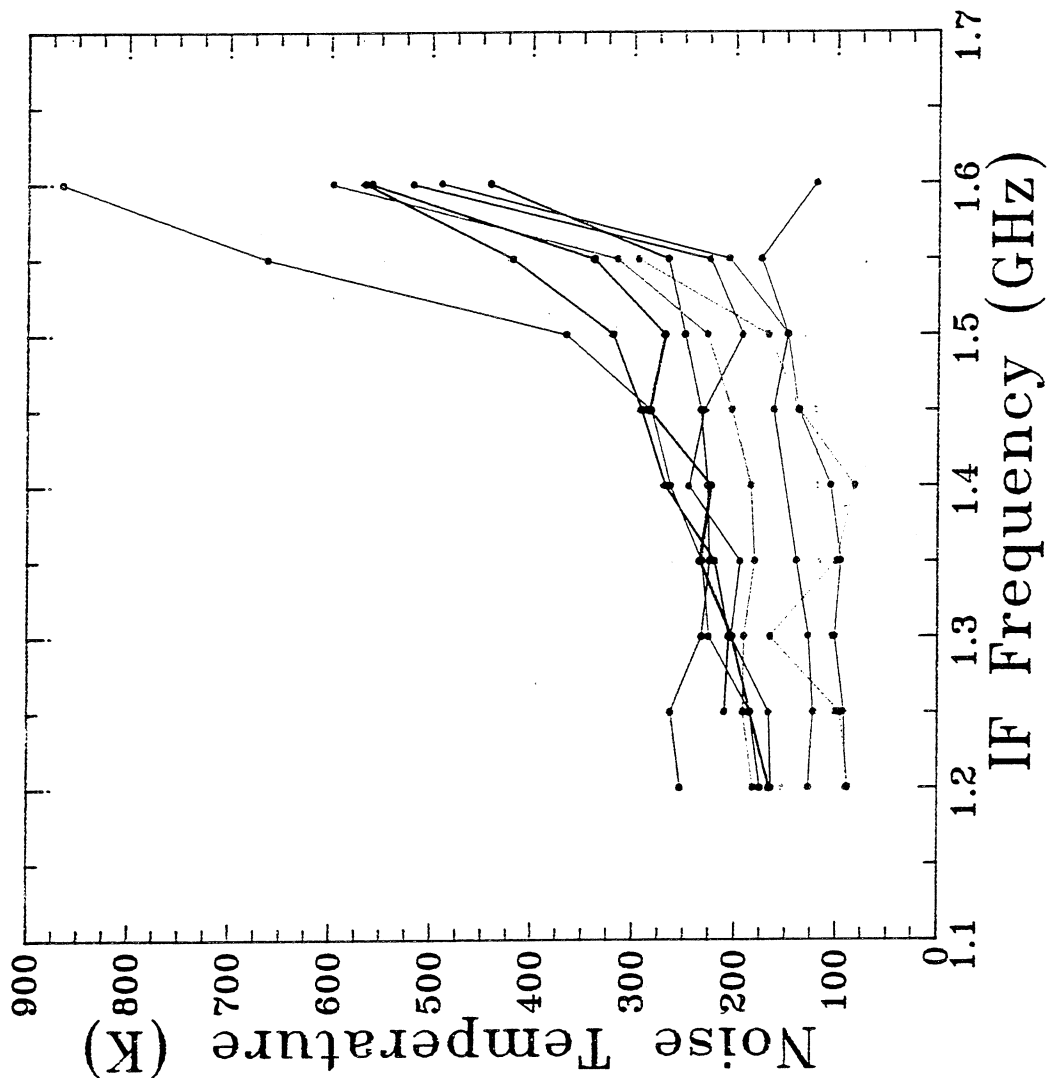

Phillip Stimson,  
Robert Cengler,  
Peter Siegel,  
Scott Cypher,  
Henry LeCuc

Jet Propulsion  
Laboratory

Graph shows  
mixer noise  
temperature  
versus IF  
frequency.  
The LO power  
was fixed at  
2.0 dB arb.

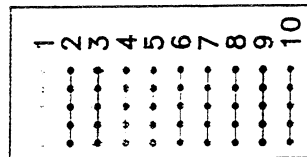

# Submillimeter-Wave "Schmidt" Telescope

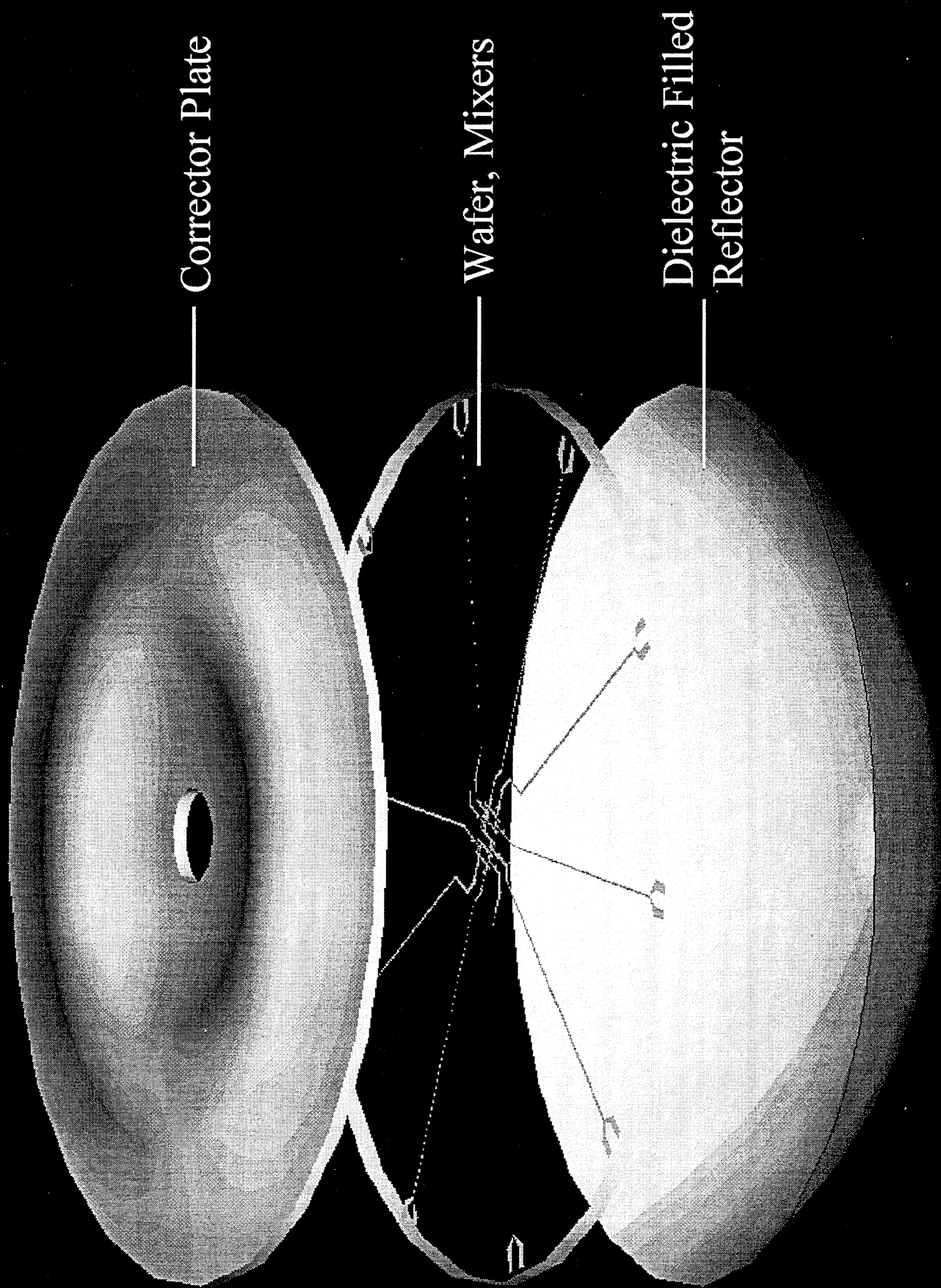

## Dielectric-Filled Parabola: Semiconductor Mixer

(P. Siegel, R. P. Smith)

---

- Combined twin-slot half-wave resonant slot antenna design of Kerr, Siegel, Mattauch with coplanar feed (similar to Gearhart and Rebeiz) and integrated GaAs T-anode Schottky diode (produced by R. Peter Smith and S. Martin) on silicon DFP to produce 2.5 THz planar semiconductor mixer concept
- Mixer prototyped at 200 GHz - Measured noise temperature  $\approx 1000\text{K}$  DSB with  $25\Omega$  planar diode (performance improvement of 2X expected with better device)
- Currently fabricating 2.5 THz version

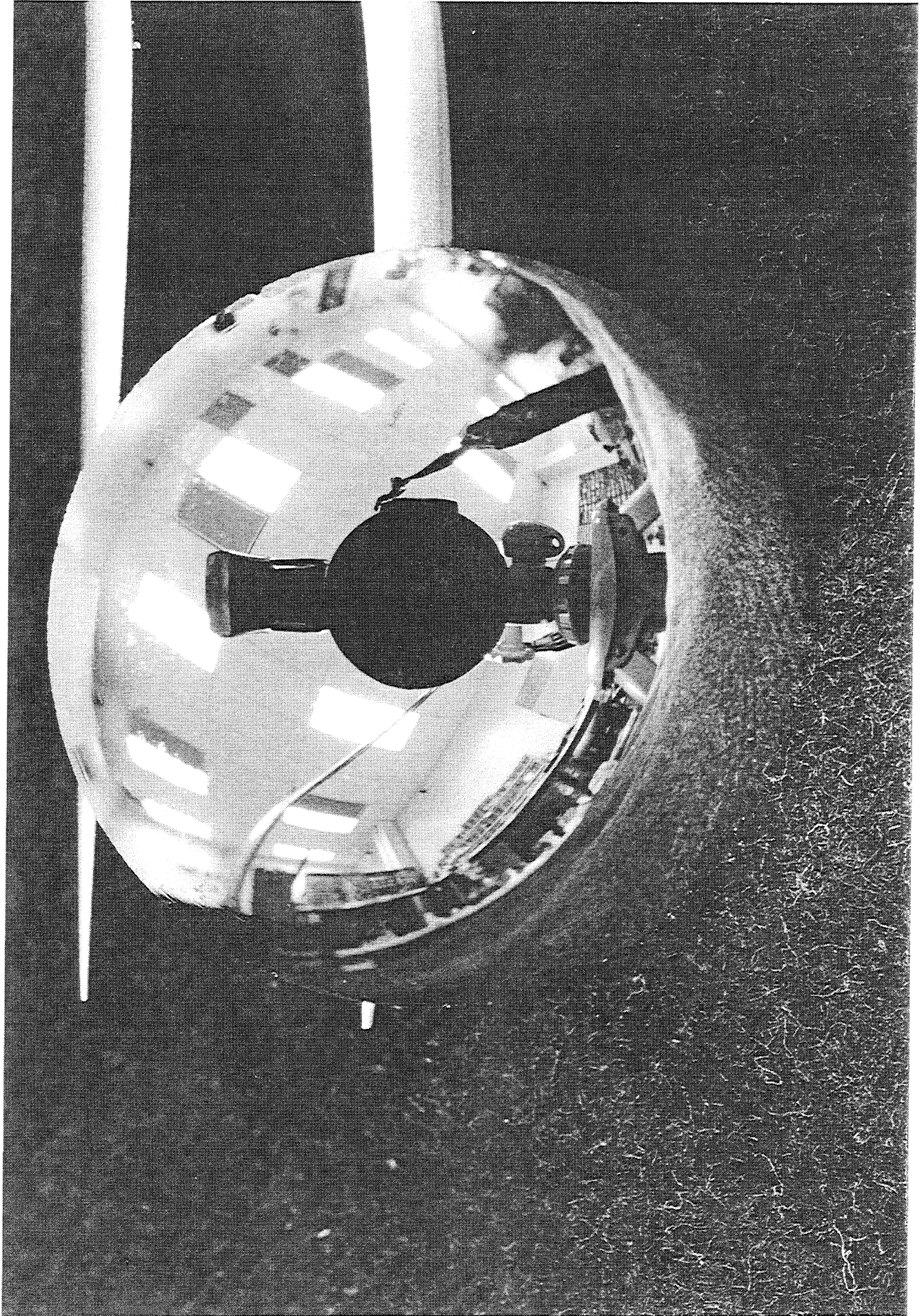



**200 GHz Open Structure Mixer Prototype: Twin-Slot Antennas on a Silicon DFP**

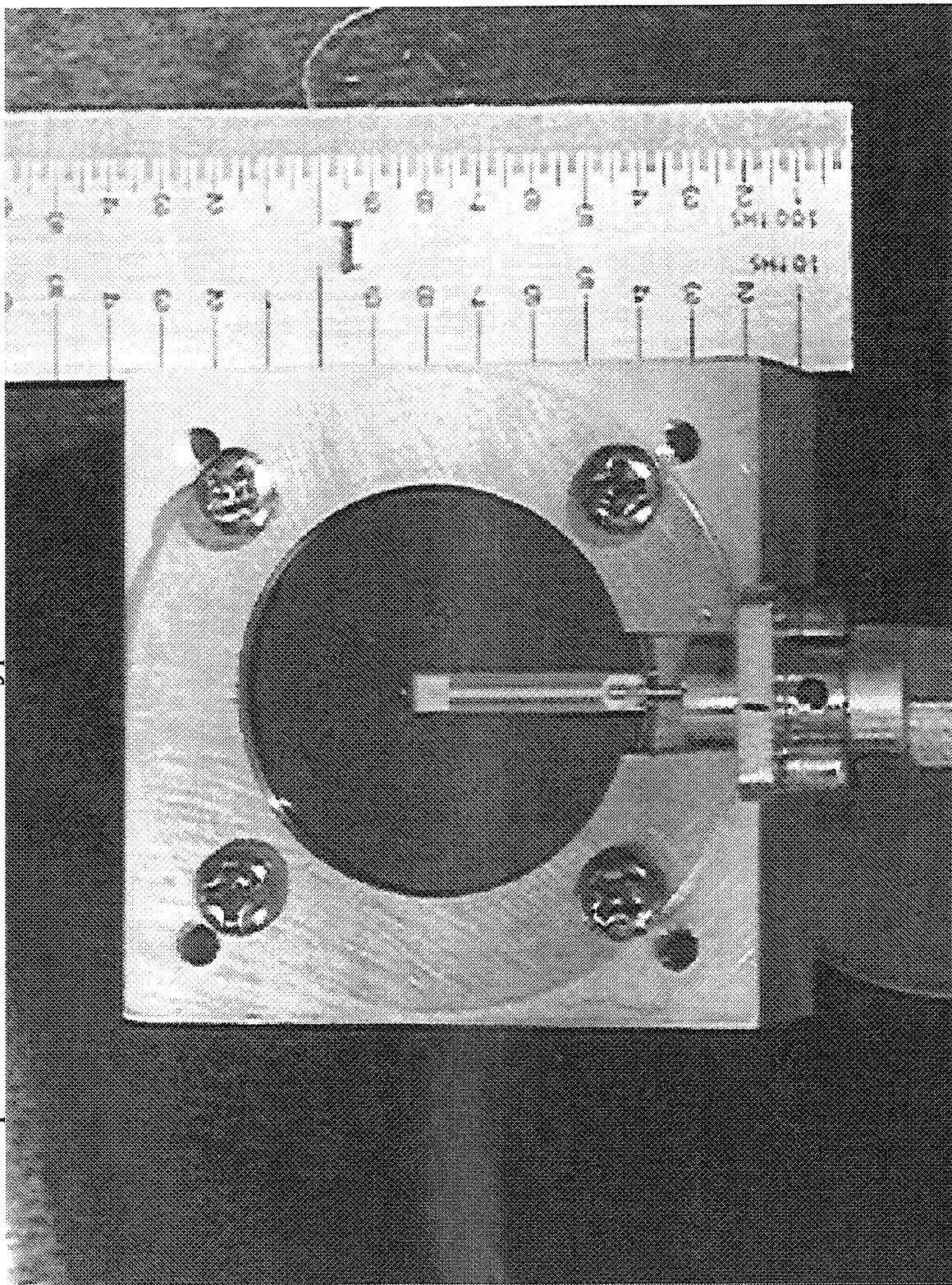

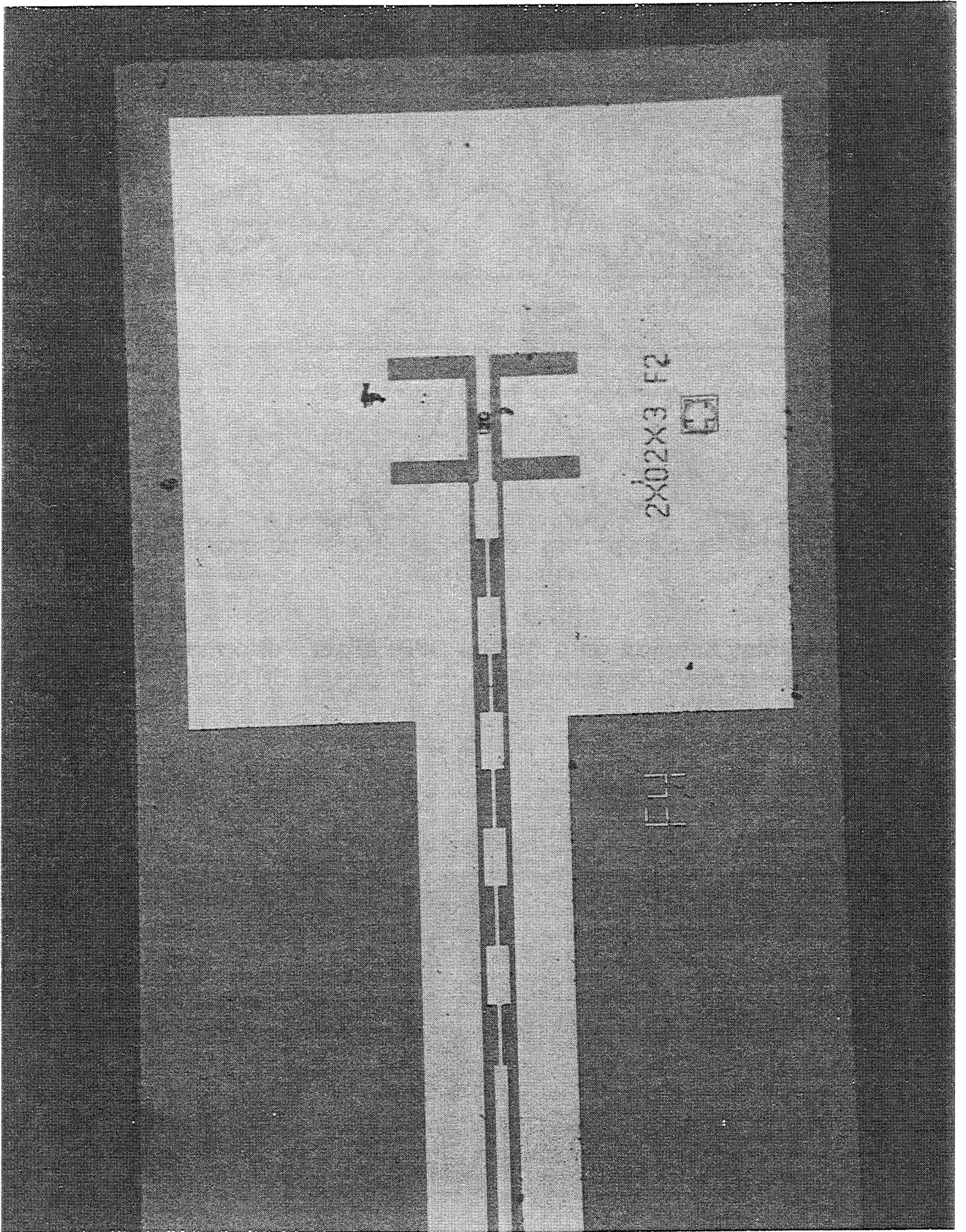

### Twin-Slot Antenna on a Silicon DFP: RF Beam Patterns

Measurement Frequency: 190GHz

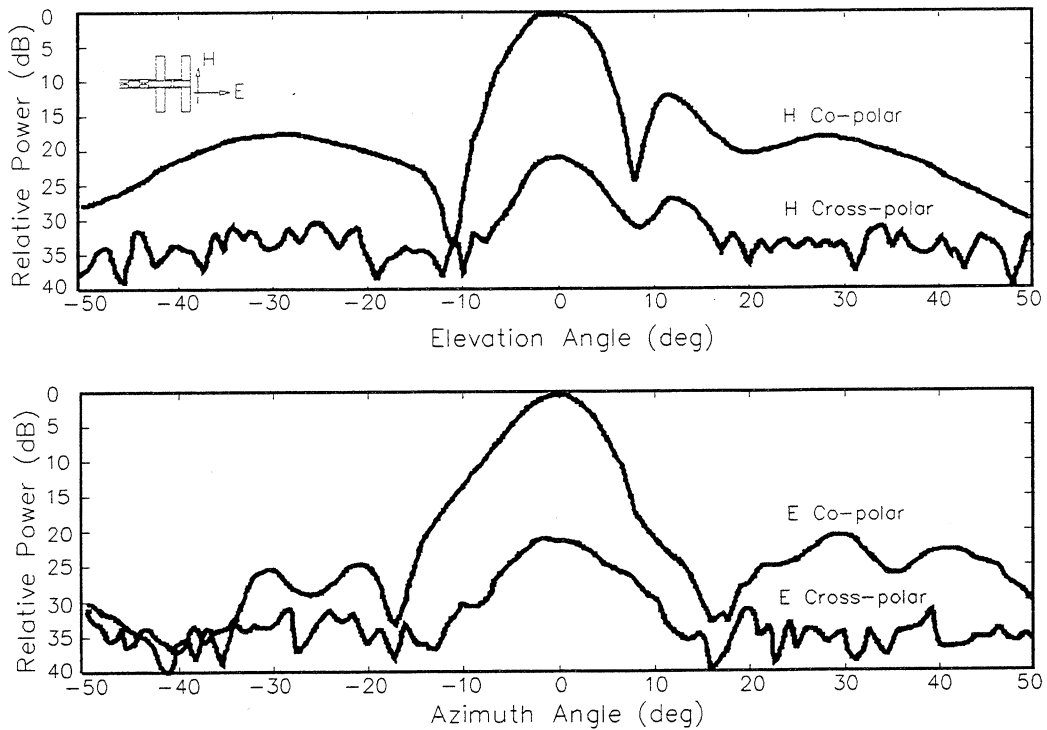

### Twin-Slot Antenna on a Silicon DFP: Mixer Performance

Diode Parameters:  $R_s=25$  Ohms,  $I_s=8e-15$  A,  $n=1.23$ ,  $\phi=0.9V$ ,  $C_{j0}$  (nominal)=3.5 fF

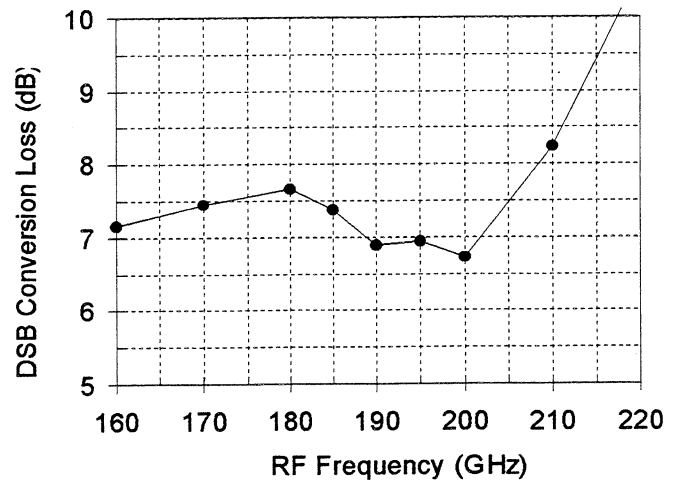
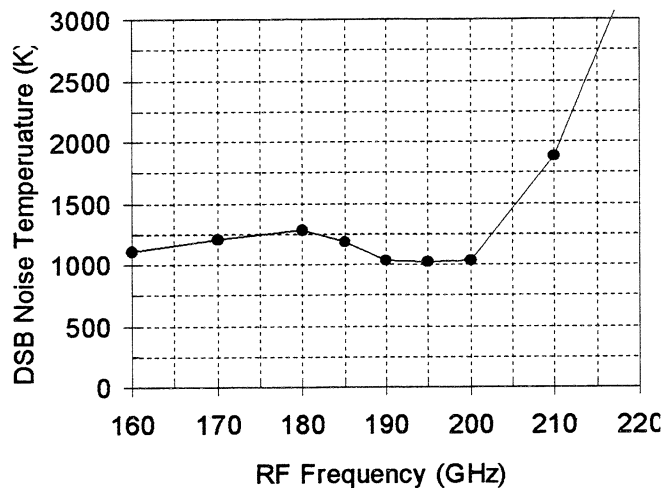

## **Dielectric-Filled Parabola: Planar Multiplier**

(M. Kim, R.P. Smith, S. Martin, P. H. Siegel)

---

- Combined quad-bridge-diode multiplier concept and two-pair of cross polarized half-wave resonant slot antennas to produce all-planar doubler and quadrupler circuits for submillimeter wavelengths
- Novel coplanar-waveguide matching circuitry designed to efficiently couple diodes to input/output antennae
- Two-component matching layer (Corning 9606 ceramic & polyethylene sheet) combined to yield simultaneous beam match to silicon DFP at input and output
- Complete HFSS/Momentum analysis yields beam properties, optimum input/output impedances
- 20 GHz model using quartz parabola with commercial quad-mixer diode package gives performance within predicted limits
- Currently fabricating 160-320 GHz and 320-640 GHz doubler and 160-640 GHz quadrupler on silicon DFP

## Double-slot antenna multiplier

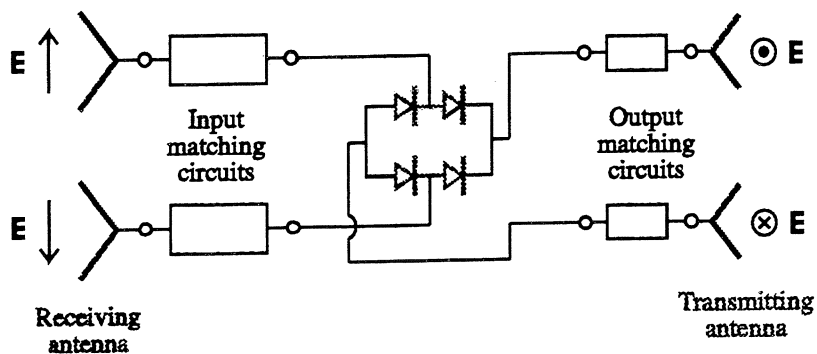

Circuit layout

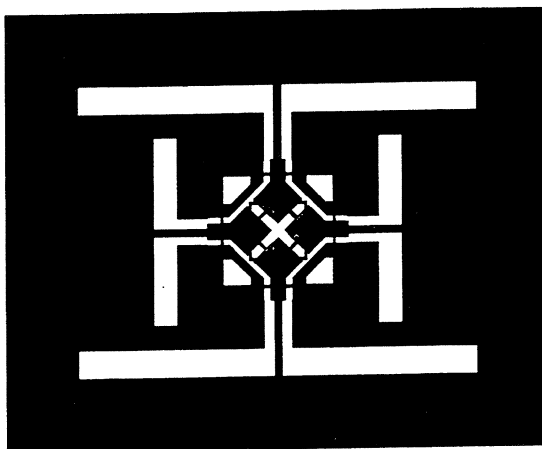

600/1200 GHz doubler performance prediction

Input power level	Diode size	Expected output power
500 $\mu$ W	0.5 $\mu$ m x 1 $\mu$ m	100 $\mu$ W
2 mW	0.5 $\mu$ m x 3 $\mu$ m	600 $\mu$ W

## 10/20 GHz Mixer Diode Scaled Model Measurement Results

### Setup

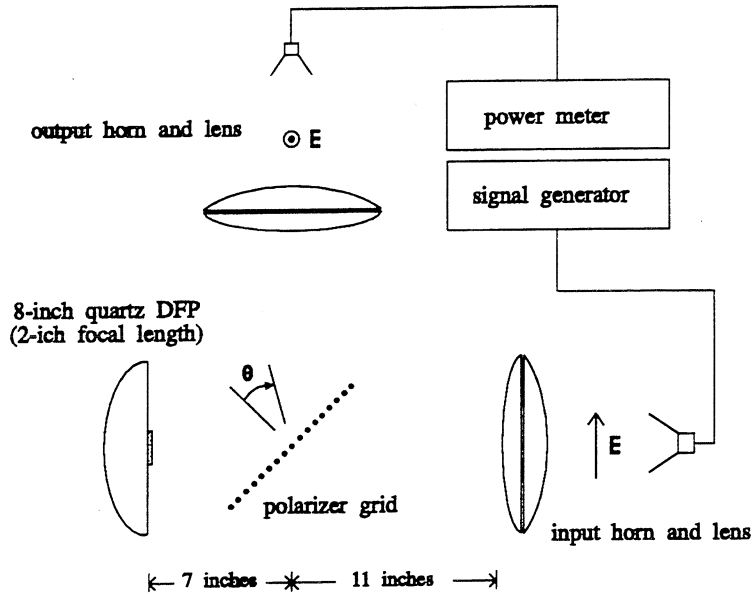

### Results

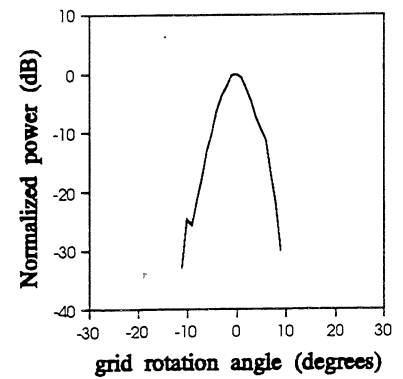
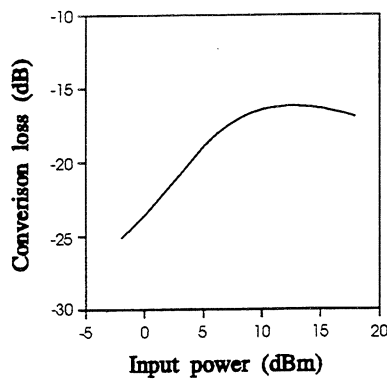
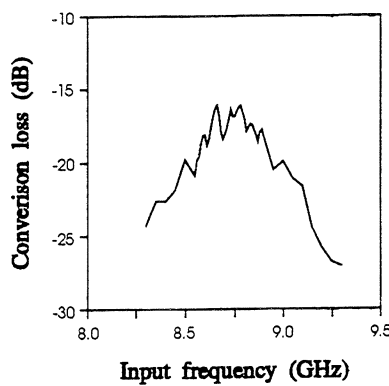

Q-O M

## Dielectric-Filled Parabola: Conclusions

---

- The dielectric-filled parabola is an alternative thick substrate lens approach which has proven useful in several unique submillimeter-wave applications
- For wavelengths greater than 1 mm it can be fabricated with simple molding or lapping techniques. For higher frequencies, diamond turning must be used to produce the final surface finish
- It has the advantages (or disadvantages) of both a reflector and a lens with the principle benefit, perhaps, being low-to-high f-number conversion in a single step and loose alignment tolerances
- As with large primary fed parabolic reflectors, it has the disadvantage of suffering from feed blockage and substantial coma lobe in off-axis beams
- As a footnote: an interesting application proposed for the DFP by an individual from a 'real' company included molded plastic headlights and flashlight spots fed by an embedded lamp - it was potentially much less expensive than forming precision sheet metal reflectors! May the wonders of science never cease.