

A Subharmonically Pumped HFET Grid Mixer

Robert M. Weikle, II[†], Niklas Rorsman, Herbert Zirath
and Erik L. Kollberg

Chalmers University of Technology
S-412 96 Göteborg SWEDEN

[†] University of Virginia
Charlottesville, VA 22903-2442 U.S.A.

Abstract— In this work, we report the demonstration of a quasi-optical subharmonically pumped grid mixer. The grid consists of a 4×4 array of dual gate Heterojunction Field Effect Transistors (HFET's) which are connected in a crossed dipole configuration. Both the drains and sources of the devices are grounded, thus eliminating possible instabilities. The LO and RF signals are applied to the grid quasi-optically and with orthogonal polarizations. This enhances the isolation between the LO and RF as well as allowing for the possibility of independent impedance tuning for both signals. The IF signal is removed from the bias lines with an SMA connector. The grid was designed for and tested in the *K*-band (18-26.5 GHz), where a minimum conversion loss of 16 dB was obtained at an RF frequency of 19 GHz and an LO power of 3 dBm per device. This is comparable to conventional dual gate HFET mixers which typically have a conversion loss between 10 dB and 15 dB for the same LO power.

I. INTRODUCTION

The development of quasi-optical arrays as a means of power generation at millimeter-wave frequencies continues to be a subject of growing interest. Planar arrays or grids of transistors have produced output powers at frequencies as high as 35 GHz [1,2] and with DC-to-RF conversion efficiencies as high as 20 % [3]. In addition to oscillators, a variety of other components have been demonstrated as quasi-optical grids, including phase shifters [4], multipliers [5], amplifiers [6], and mixers [7]. One benefit gained by using quasi-optical grids is an enhancement of power-handling capability or dynamic range. This is particularly important at millimeter-wave and submillimeter-wave frequencies where free-space power combining can be most efficient. However, even with an increased dynamic range, other important grid parameters, such as noise performance and conversion loss or gain, are expected to be comparable with those for circuits containing a single device. The increase in dynamic range is particularly important for applications

such as power combining or frequency multiplication. It could also prove useful in receiver applications, especially when the power handling of the nonlinear mixing element is fundamentally limited as it is for SIS junctions.

Unfortunately, the increased dynamic range of a grid mixer implies a corresponding increase in the LO power required for pumping. This can be a serious drawback, especially at millimeter-wave frequencies where higher power comes at a much higher cost. One possible solution is to use a power combining array for the LO signal. An alternative is to use a lower frequency, higher power source in conjunction with a multiplier. Each of these suggestions merit investigation. A different approach is to explore grid mixer configurations that allow subharmonic pumping. This permits the use of a lower frequency LO source without the need for additional multipliers. In this paper, we present the design and demonstration of a subharmonically pumped grid mixer which uses dual gate HFET's as the mixing element.

II. THE DUAL GATE HFET

A photograph of the dual gate HFET is shown in Fig. 1. This device was fabricated at Chalmers and consists of two HFET cells connected in parallel and fabricated on a δ -doped pseudomorphic AlGaAs-InGaAs-GaAs substrate grown by Quantum Epitaxial

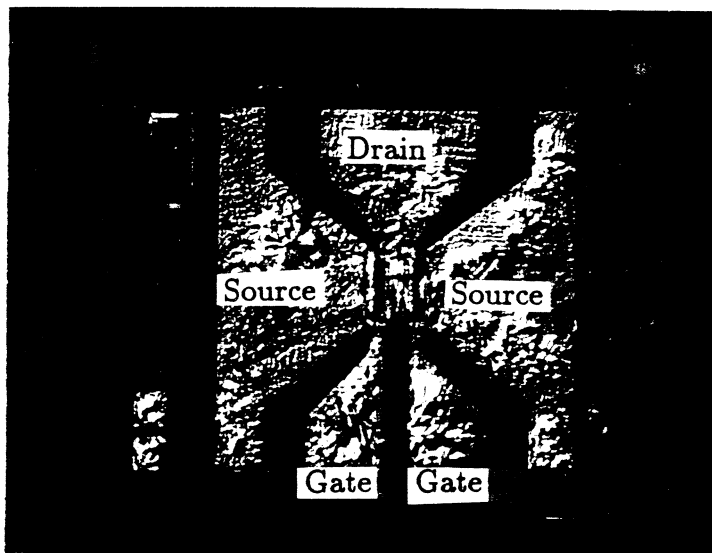

Figure 1. Photograph of the dual gate HFET. In a subharmonic mixer, the gates are driven 180° out of phase.

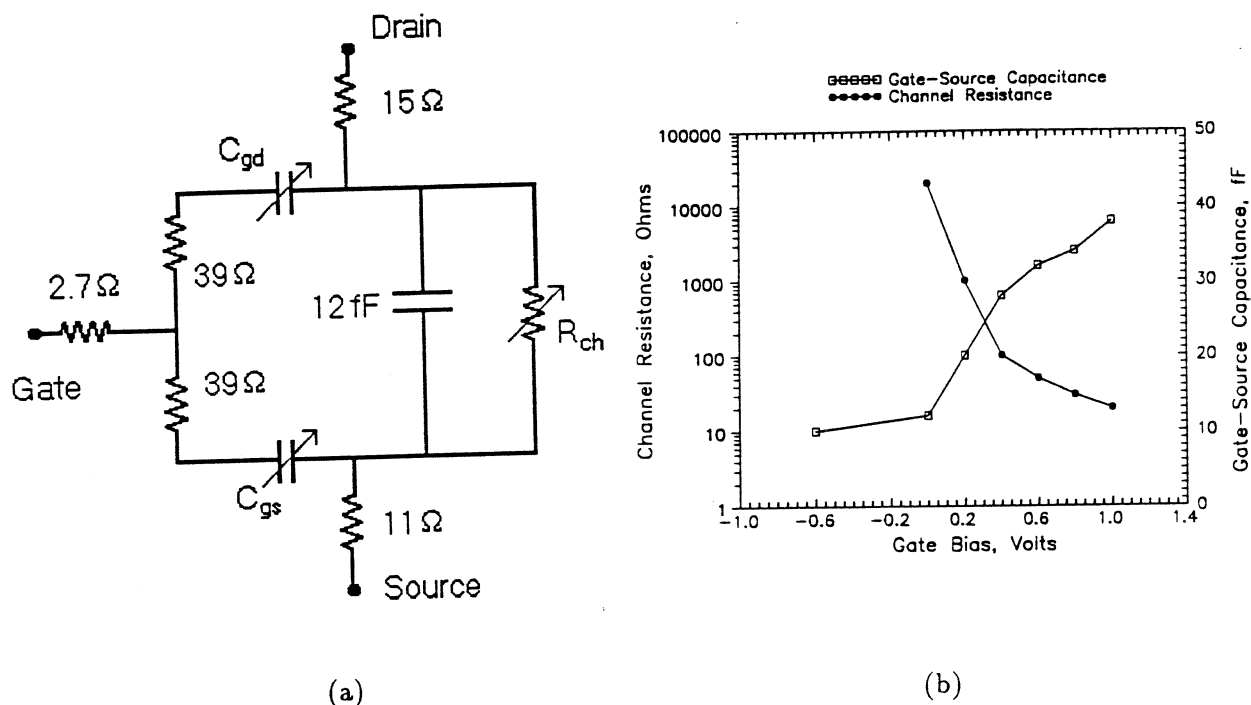

Figure 2. (a) Lumped-element circuit model for one cell of the dual gate HFET. The model was determined from DC and s -parameter measurements up to 60 GHz. (b) HFET channel resistance and gate-source capacitance as a function of DC gate voltage.

Design, Inc. (QED). The 2-DEG sheet concentration was determined by Hall measurements to be $3.5 \times 10^{12} \text{ cm}^{-3}$, and the electron mobility to be $4800 \text{ cm}^2/\text{V}\cdot\text{s}$ at room temperature. Mushroom shaped gates were fabricated using electron beam lithography and a two-layer resist lift-off procedure. The gate length is approximately $0.15 \mu\text{m}$. The drain and source ohmic contacts were formed using a Au/Ge/Au/Ni/Au metallization and annealing at 350°C for about 60 sec. An equivalent circuit model for the HFET was found from DC and s -parameter measurements up to 60 GHz. The f_{max} of the device is estimated to be 120 GHz and the f_T to be 100 GHz. The HFET model, with $V_{ds} = 0$ is shown in Fig. 2(a).

When used as a resistive mixer, an LO signal is applied to the gate. This signal modulates the gate voltage which in turn modulates the resistance of the drain-source channel. The dependence of the channel resistance on DC gate bias is shown in Fig. 2(b). This dependence is described relatively well by the empirical expression [8]:

$$R_{ch} = R_0 e^{-kV_g} + R_1$$

The sum of R_0 and R_1 corresponds to the channel resistance at zero gate bias and k

determines the slope of the $\log(R_{ch})$ vs. v_{gs} characteristic. R_1 is the minimum channel resistance determined by the 2-DEG concentration and geometrical parameters.

III. GRID DESIGN

A photograph of the grid is shown in Fig. 3(a). The grid consists of an array of identical unit cells, each of which contains a single dual-gate HFET chip. Copper strips running across the dielectric substrate in both the vertical and horizontal directions allow DC bias connections and serve to couple the devices to incident radiation. Referring to Figure 3(b), the horizontal leads (which are $100\ \mu\text{m}$ wide) are wire-bonded to the HFET gates. In this configuration, an incident wave polarized parallel to the gate leads induces currents which drive the gates of each device out of phase. As a result, the combined channel resistance of the paralleled HFET's is modulated at *twice* the frequency of the incident LO signal. The $600\ \mu\text{m}$ wide vertical leads are wire-bonded to the drain and sources of each device. Radiation incident on the grid with a vertical polarization sees the inductance of these leads in series with the modulated channel resistance. Mixing products are thus generated across the drain and source leads of each unit cell.

The substrate of the grid is Rogers *Duroid* 6010 with a dielectric constant of 10.5 and thickness of $635\ \mu\text{m}$. The drains and sources of the HFET's are grounded through 1 cm long gold bond wires (diameter of 1 mil). Gate bias is brought in from the sides, also on gold bond wire. An IF signal is removed from the top and bottom bias lines of the grid with an SMA connector.

The grid was designed using the equivalent circuit model shown in Fig. 4 along with the HFET lumped element model and Hewlett-Packard's *Microwave Design System* software [9]. Vertical and horizontal leads are represented by lumped inductors whose values are calculated using the EMF method [10,11]. A section of transmission line represents the dielectric substrate. Shunt admittances Y_{LO} and Y_{RF} account for reflections and losses presented to the LO and RF signals from the opposite side of the grid. In our simulations, these admittances model polarizers that are adjusted to independently tune the LO and RF. The size of the unit cell is 3 mm and was chosen so that the RF signal was well matched at 20 GHz.

IV. MEASUREMENTS

To measure the performance of the grid, a *K*-band horn antenna was placed 45 cm in front of the array and the SMA IF output was connected to a Tektronics 2754P spectrum analyzer. The LO signal was injected from behind (through the dielectric substrate) with an X-band open-ended waveguide placed 5 cm from the grid. The experimental setup

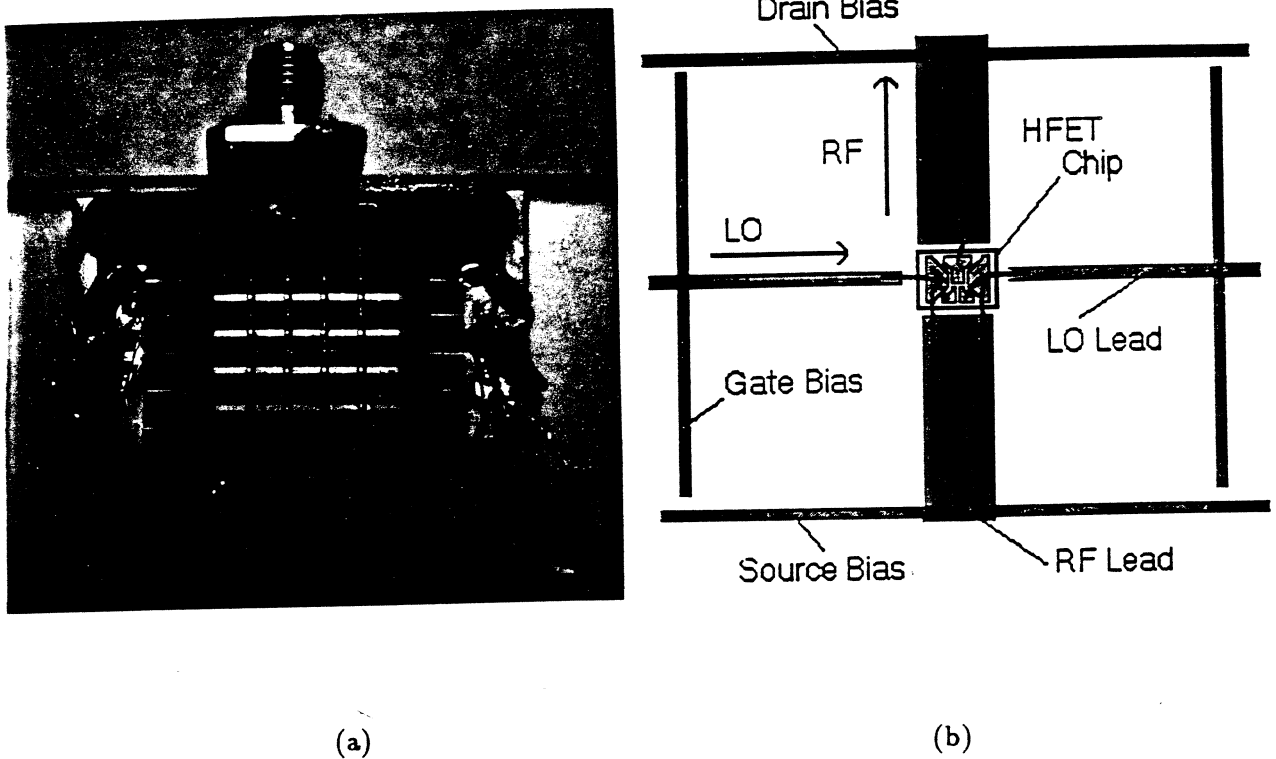

Figure 3. (a) Photograph of the 16-element HFET grid mixer. The LO signal is vertically polarized and the RF horizontally polarized. (b) Schematic of the grid unit cell showing how the chip is connected with bonding wire. Note that the unit cells in Figure 3(a) are rotated by 90°

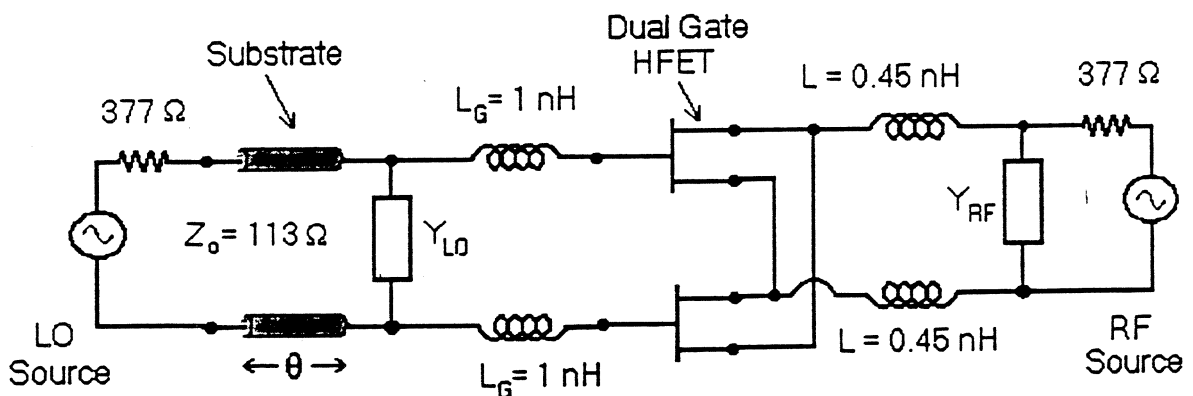

Figure 4. Equivalent circuit model for the subharmonically-pumped mixer grid..

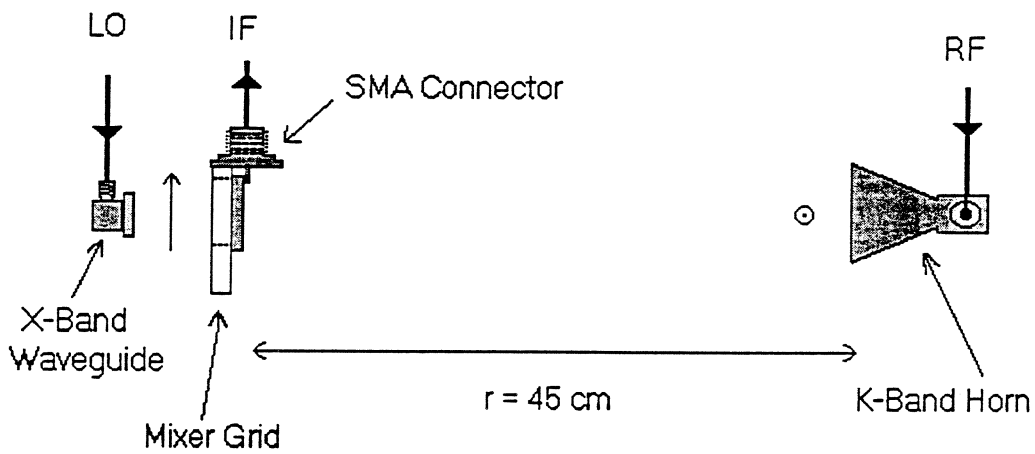

Figure 5. Experimental setup used to measure the mixer conversion loss. The LO is fed through an HP 8349B amplifier to an open-ended X-band waveguide. The IF signal is observed using a Tektronics 2754P Spectrum Analyzer.

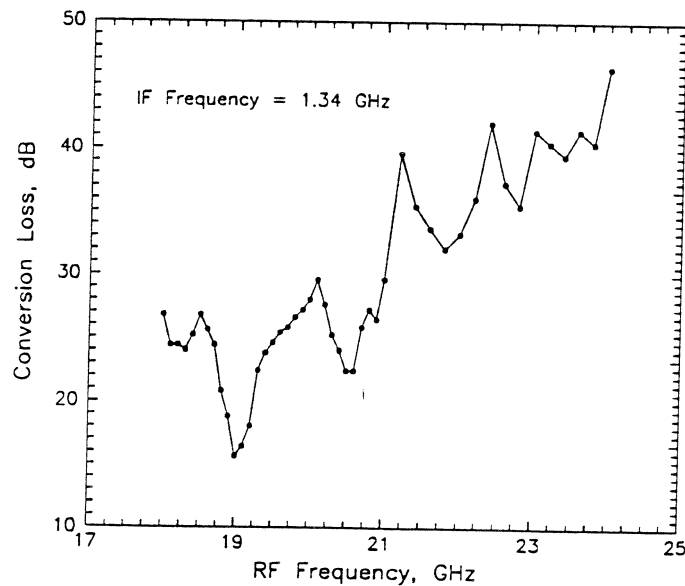
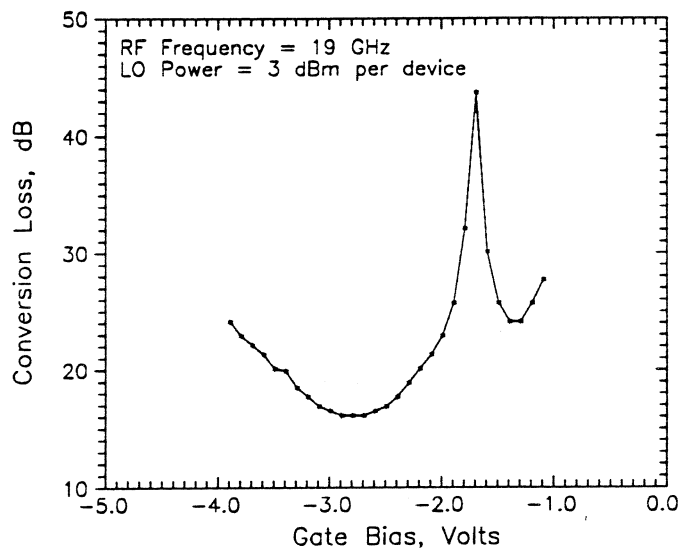
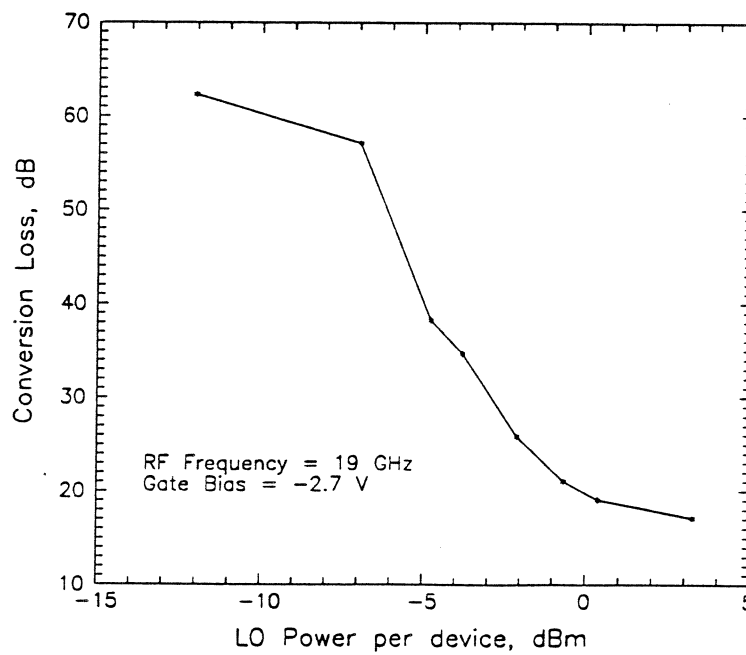

Figure 6. Conversion loss of the grid as a function of RF frequency. The IF is kept constant at 1.34 GHz.



(a)



(b)

Figure 7. Conversion loss of the subharmonically pumped grid mixer as a function of (a) gate bias and (b) LO power incident on the grid.

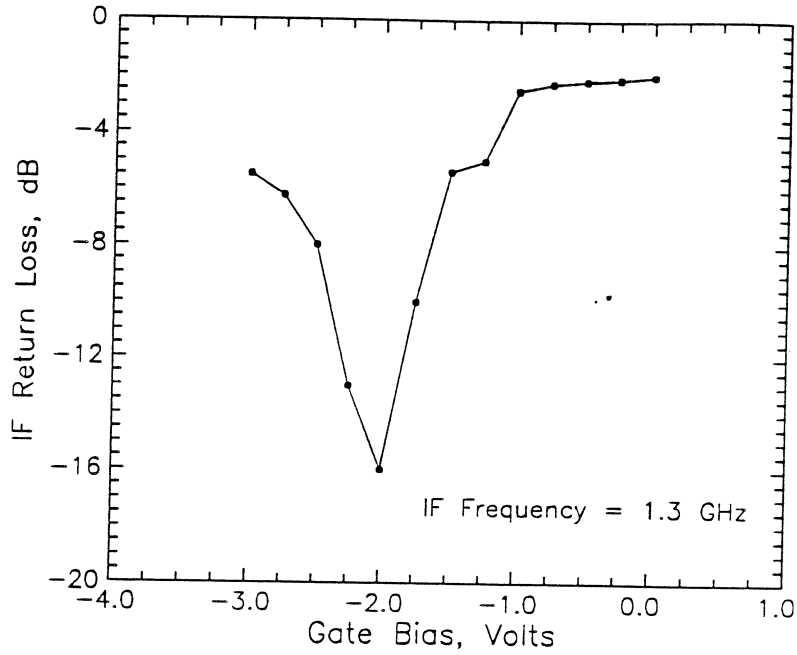

Figure 8. Measured IF return loss at 1.3 GHz as a function of DC gate bias.

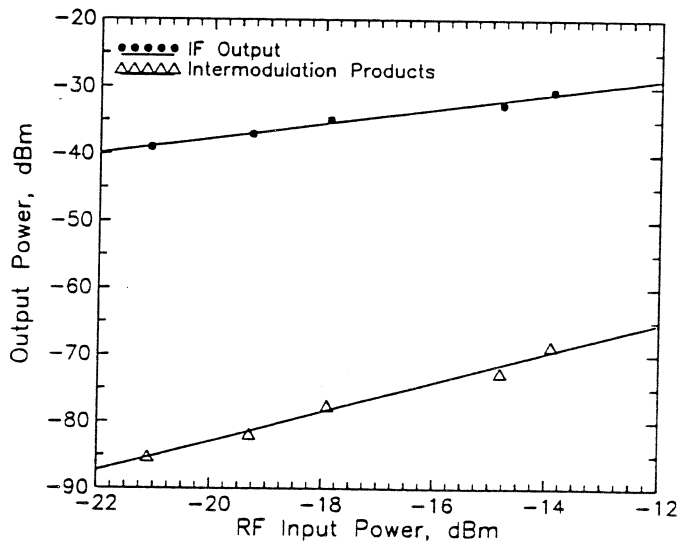

Figure 9. Measured IF output and intermodulation products of the grid mixer. Extrapolation gives a third-order intercept point of $P_{out} = 6.8$ dBm.

is shown in Fig. 5. To measure the RF power incident on the array, two identical horns were positioned facing one another and separated by 90 cm (twice the distance to the grid). A sheet of absorber with an aperture equal to the size of the grid was placed halfway between the horns. The free-space pathloss as a function of frequency was then measured with one horn connected to a sweeper and the other connected to a power meter. A similar procedure was used to find the incident LO power.

The conversion loss of the mixer grid was measured as a function of RF frequency (with a fixed IF), DC gate bias, and incident LO power. These results are shown in Fig. 6 and Fig. 7. A minimum conversion loss of 16 dB occurred at an RF frequency of 19 GHz, a gate bias of -2.7 V, and an incident LO power of 3 dBm per device. It should be noted that these measurements were done without input or output polarizers to tune the LO and RF impedances. The IF match was also measured using an HP 8510 network analyzer. Figure 8 shows the measured IF return loss at 1.3 GHz as a function of gate bias. In addition, we investigated the linearity of the mixer and attempted to measure the third-order intercept point. The IF signal and intermodulation products as a function of incident RF power is shown in Figure 9. Because the signal levels are quite low, the validity of extrapolating to find the intercept point is questionable. However, the extrapolated intercept point $P_{out} = 6.8$ dBm agrees favorably with the expected improvement of about 11 dB over a single element subharmonically-pumped mixer.

SUMMARY

In this paper, we have presented the design and performance of a subharmonically pumped HFET grid mixer. The grid mixer is attractive because of its quasi-optical coupling and increased dynamic range. Another attractive feature is the large degree of isolation between the LO and RF ports resulting from the physical layout of the grid. The measured conversion loss is comparable to other subharmonic mixers of similar design and could probably be improved with more careful modeling and by providing separate input and output polarizers for impedance tuning.

ACKNOWLEDGMENTS

The authors would like to thank Dr. Ilcho Angelov, Dr. Björn Albinsson, Hans Grönqvist, and Christer Karlsson for their expertise, advice, and help with fabrication.

REFERENCES

- [1] E.A. Sovero, M. Kim, R.M. Weikle, II, D.S. Deakin, W.J. Ho, J.A. Higgins, and D.B. Rutledge, "A Monolithic 35 GHz HBT Quasi-Optical Grid Oscillator," *IEEE GaAs IC Symposium*, Miami, FL, October 1992.

- [2] A Torabi, H.M Harris, R.W. McMillan, S.M. Halpern, J.C. Wiltse, C.J. Summers, "Planar Grid Oscillator for Quasi-Optical Power Combining at 37 GHz," *Fourth Int. Symposium on Space Terahertz Tech.*, Los Angeles, CA 1993.
- [3] R.M. Weikle, II, M. Kim, J.B. Hacker, M.P. De Lisio, D.B. Rutledge, "Planar MES-FET Grid Oscillators Using Gate Feedback," *IEEE Trans. Microwave Theory Tech.*, MTT-40, pp. 1997-2003, November 1992.
- [4] W.W. Lam, C.F. Jou, H.Z. Chen, K.S. Stolt, N.C. Luhmann, Jr., D.B. Rutledge, "Millimeter-Wave Diode-Grid Phase Shifters," *IEEE Trans. Microwave Theory Tech.*, MTT-36, pp. 902-907, May 1988.
- [5] C.F. Jou, W.W. Lam, H.Z. Chen, K.S. Stolt, N.C. Luhmann, Jr., D.B. Rutledge, "Millimeter-Wave Diode-Grid Frequency Doubler," *IEEE Trans. Microwave Theory Tech.*, MTT-36, pp. 1507-1514, November 1988.
- [6] M. Kim, *et al.*, "A Grid Amplifier," *IEEE Microwave and Guided Wave Lett.*, vol. 1, no. 11, pp. 322-324, November 1991.
- [7] J.B. Hacker, R.M. Weikle, II, M. Kim, M.P. De Lisio, D.B. Rutledge, "A 100-Element Planar Schottky Diode Grid Mixer," *IEEE Trans. Microwave Theory Tech.*, MTT-40, pp. 557-562, March 1992.
- [8] H. Zirath, I. Angelov, N. Rorsman, "A Millimeter-Wave Subharmonically Pumped Resistive Mixer based on Heterostructure Field Effect Transistor Technology," *1992 MTT-S International Symposium Digest*, pp. 599-601, Albuquerque, NM.
- [9] "HP 85150B Microwave Design System," Hewlett-Packard Company, Networks Measurements Division, 1400 Fountaingrove Parkway, Santa Rosa, CA 95403, U.S.A.
- [10] P.S. Carter, "Circuit Relations in Radiating Systems and Applications to Antenna Problems," *Proc. IRE*, vol. 20, pp. 1004-1041, June 1932.
- [11] R.L. Eisenhart, P.J. Khan, "Theoretical and Experimental Analysis of a Waveguide Mounting Structure," *IEEE Trans. Microwave Theory Tech.*, MTT-19 pp. 706-719, August 1971.