

GaAs SCHOTTKY DIODES FOR THz MIXING APPLICATIONS

P.A.D. Wood, W.C.B. Peatman, D.W. Porterfield, and T.W. Crowe

*Semiconductor Device Laboratory
Department of Electrical Engineering
University of Virginia
Charlottesville, VA 22903*

ABSTRACT

GaAs Schottky diodes are currently the most sensitive heterodyne receiver elements for applications above 1 THz which require high spectral resolution and broad bandwidth. Diode performance can be further improved by optimizing parameters such as anode diameter and doping concentration. Based on previous experimental and theoretical research, improved diodes have been fabricated in the Semiconductor Device Laboratory of the University of Virginia. These diodes have an epitaxial layer doping density of $1 \times 10^{18} \text{ cm}^{-3}$ and zero-bias junction capacitance as low as 0.25 fF. Diode performance was evaluated using video responsivity, mixer noise temperature and mixer conversion loss. These measurements have confirmed earlier predictions that for higher frequencies higher doping densities and smaller anode diameters must be used.

I. BACKGROUND

Several current and planned NASA programs require high sensitivity heterodyne receivers for the frequency range from 600 GHz through 2.5 THz. These include both atmospheric and radio astronomy missions. The Microwave Limb Sounder (MLS), which will be flown on the Earth Observing System, will have receivers at 215 GHz, 440 GHz, 640 GHz and 2.5 THz for atmospheric measurements related to ozone depletion [1]. A planned astronomy mission (SMIM) will require receivers covering the spectrum from 400 GHz through 1.2 THz [2]. Although superconducting technology is being pursued in these frequency ranges, and is in fact better than Schottky technology by at least a factor of two at 500 GHz [3,4,5], it is not clear when, or if, the SIS junctions will be extended to THz frequencies. Also, Schottky diodes are much more convenient for many applications due to their ability to operate at any temperature in the range

from below 20K to above 300K. In the frequency range above about 600 GHz the only receivers presently available for these missions are based on GaAs Schottky mixer diodes. Thus, any improvement in the performance of these diodes can have a great impact on these NASA programs.

GaAs Schottky diodes were first used in heterodyne receivers at microwave and millimeter wavelengths. In the 1970s it was shown that diodes with low epitaxial layer doping density can be extremely sensitive mixer elements when operated at low temperature [6]. This led to the development of greatly improved Schottky receivers at millimeter wavelengths, including a system that yielded a mixer noise temperature of only 35K DSB at about 100 GHz (<8 hv/k) [7]. It is remarkable that nearly ten years later this result is quite comparable to the best results obtained with SIS receivers at this frequency, particularly when one considers that the Schottky receiver need only be cooled to 20K.

Based on this success, there has been a large bias toward using low doped diodes at all frequencies. However, recent investigations of submillimeter wavelength receivers have shown that this may not be the optimum diode design. In 1989 Harris et. al published a detailed study of noise in an 800 GHz Schottky receiver [8]. This study was later extended to consider the diode noise [9]. It was shown that at 800 GHz the receiver noise was not dominated by the diode shot noise, as was the case at millimeter wavelengths, but rather by hot-electron noise. Thus, it was proposed that diodes with higher doping density and smaller anode diameter would reduce receiver noise by lessening the hot-electron noise.

Other studies have led to similar conclusions. For example, Bhapkar investigated the series impedance of the Schottky diodes by a finite difference technique that included all of the most important phenomena at THz frequencies [10]. This work showed clearly that higher doping density and smaller anodes were required to increase the cut-off frequency (related to the $R_s C_{j0}$ product) to the point where THz performance was optimized. At the same time several empirical studies were indicating that such diodes always performed better at high frequency than the older, lower doped diodes. Thus, in 1991 we decided to fabricate diodes with epitaxial layer doping densities as high as 1×10^{18} cm⁻³ and anode diameters substantially below one micron. The fabrication and RF performance of these diodes is described in the remainder of this paper.

II. DIODE FABRICATION

The best Schottky diodes at submillimeter wavelength are of the "honey-comb" type first developed by Young and Irvin [11], as shown in Fig. 1. The GaAs substrate is highly doped to reduce its contribution to the series resistance. The epitaxial layer doping density and thickness are chosen to optimize the diode performance based on a variety of trade-offs [12]. The fabrication process has been described in various previous papers [13,14], and will only be outlined here. First, the epitaxial layer doping density is measured by a capacitance-voltage profiling technique. An anodic oxidation process is then used to remove a carefully controlled amount of the epitaxial layer, leaving behind the thickness required by the diode design. Once the soft anodic oxide is removed in an acidic etch, a thin layer of SiO_2 is deposited on the wafer by chemical vapor deposition.

Following oxide deposition, the wafer is processed by standard photolithographic techniques to define holes in the oxide. For our diodes with anodes greater than about $0.5 \mu\text{m}$ in diameter, this step is carried out with contact lithography and a UV light source. However, to achieve

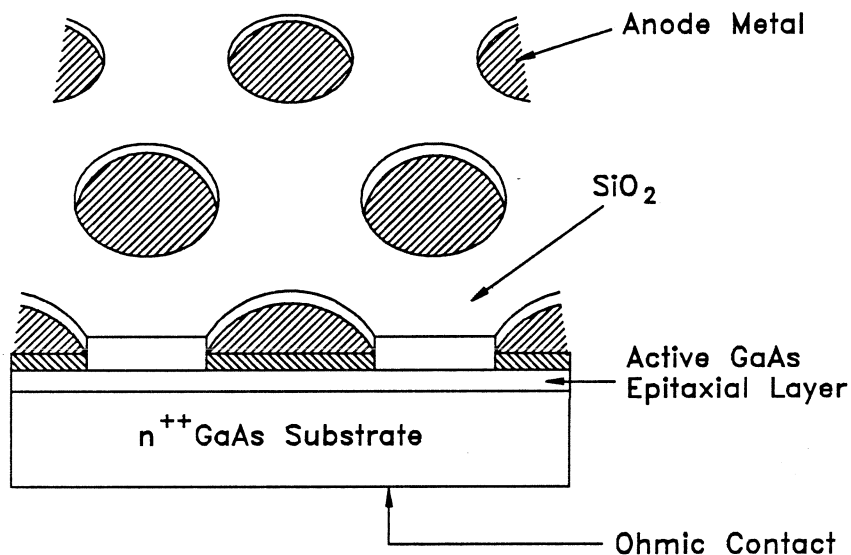

Fig. 1. A sketch of the honey-comb diode chip. The large number of closely packed anodes yields a high probability that a randomly placed whisker will contact on one of the anodes.

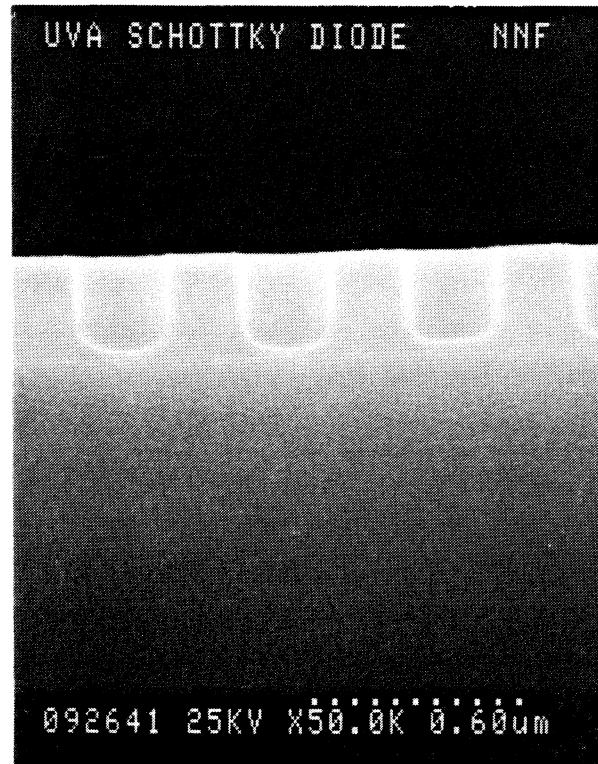

Fig. 2. A scanning electron micrograph (SEM) cross section of an oxide layer with quarter micron holes in GaAs. A small amount of oxide is left in the holes to protect the GaAs surface.

quarter-micron anodes direct-write electron beam lithography was required. This critical step was performed at the National Nanofabrication Facility at Cornell University. For all diodes, the photolithographic pattern is transferred to the oxide by reactive ion etching. This technology allows us to maintain the small size of the features and to control the depth of the etch. The control of etch depth is critical because there is evidence that the RIE etch can damage the GaAs surface, possibly creating traps and excess diode noise. Also, we would like to leave a thin layer of oxide to protect the GaAs surface during subsequent processing steps. In our process, the etch is stopped several hundred angstroms before the GaAs is exposed. Fig. 2 is an scanning electron micrograph (SEM) cross-section of a quarter micron diameter hole in SiO_2 on GaAs. The remaining oxide thickness is of order 200\AA .

After RIE, the photoresist is removed and the back-side ohmic contact is formed. This involves carefully lapping the wafer to the desired thickness (of order 100 μm), electroplating the ohmic contact metals and alloying. Throughout this process, the oxide protects the top surface of the wafer. After the ohmic contact is complete, the wafer is diced into square chips, typically 250 μm wide. Individual chips are then soldered onto metal posts for anode formation.

To form the anodes, the remaining oxide in the anode holes is removed by a wet chemical etch, and the Pt/Au Schottky contact is plated onto the exposed GaAs surface. The diodes are then tested for electrical quality (forward IV and zero-bias capacitance). An SEM of a completed quarter-micron diameter chip is shown in Fig. 3. This figure shows that the anodes are well defined and that there is sufficient oxide to help hold the contact-whisker in place. In fact, this figure is virtually identical to older SEMs of our two micron diameter diodes fabricated ten years

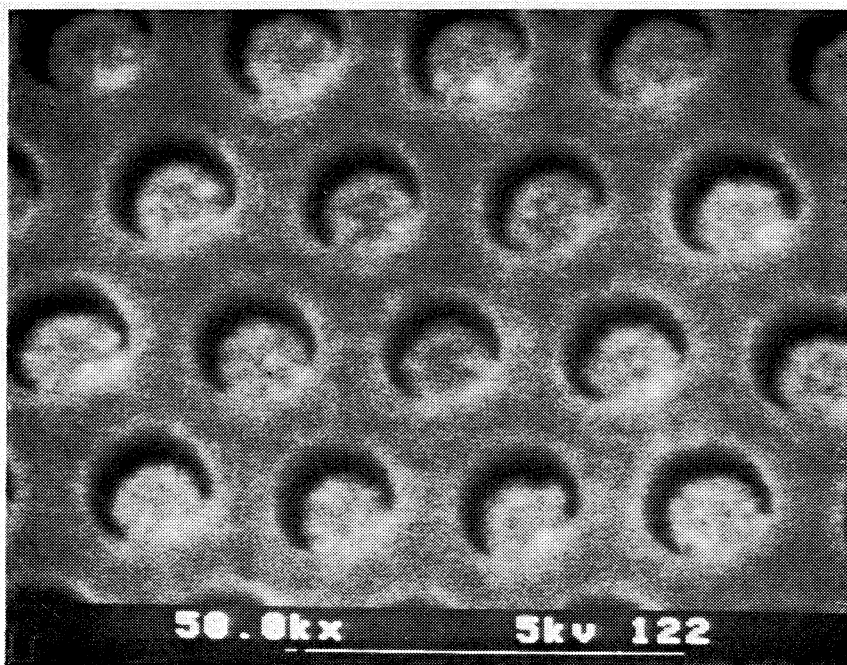

Fig. 3. A scanning electron micrograph of a completed diode chip with quarter-micron diameter anodes.

ago, except for the change in scale and the slight reduction of resolution at the higher magnification.

The characteristics of the new diodes are shown in Table I and compared to two previous batches of diodes that were fabricated on lower doped epitaxial layers. As expected, the new diodes have substantially reduced capacitance and lower $R_s C_{j0}$ product at the expense of increased ideality factor. However, based on the theoretical analyses, it is clear that this is a beneficial trade-off.

Table I: Diode Parameters

Diode	Epilayer Doping N_d (cm^{-3})	Anode Diameter d (μm)	Epilayer Thickness t_e (\AA)	Series Resistance R_s (Ω)	Zero-Bias Capacitance C_{j0} (fF)	ΔV at 10-100 μA (mV)	Ideality Factor, η 10-100 μA (mV)	Cut-off Frequency $\nu_{co} \equiv 1/2\pi R_s C_{j0}$ (THz)
1T14	1×10^{18}	0.45	400	8-10	0.9-1.1	85-90	1.4-1.5	18
1T15	1×10^{18}	0.25	300	25	0.3	90	1.5	25
1T6	4×10^{17}	0.45	1000	40	0.4	81-83	1.35-1.4	10
1I7	3×10^{17}	0.8	800	10-13	0.8-1.4	77	1.3	12.6

III. RF RESULTS

We measured the video responsivity and receiver noise temperature of several diodes with zero-bias junction capacitance, C_{j0} , ranging from 0.25 fF to 2.3 fF. These diodes were divided into two groups; those with low doping of $2-4 \times 10^{17} \text{ cm}^{-3}$ and those with high doping of 10^{18} cm^{-3} .

The video responsivity for these diodes is shown in Fig. 4. The video responsivity follows a roughly linear increase as C_{j0} is decreased. Video response is a measure of the RF induced voltage developed across the diode junction resistance, R_j , with a high impedance lock-in amplifier. The largest video response occurs when the junction resistance is much larger than the

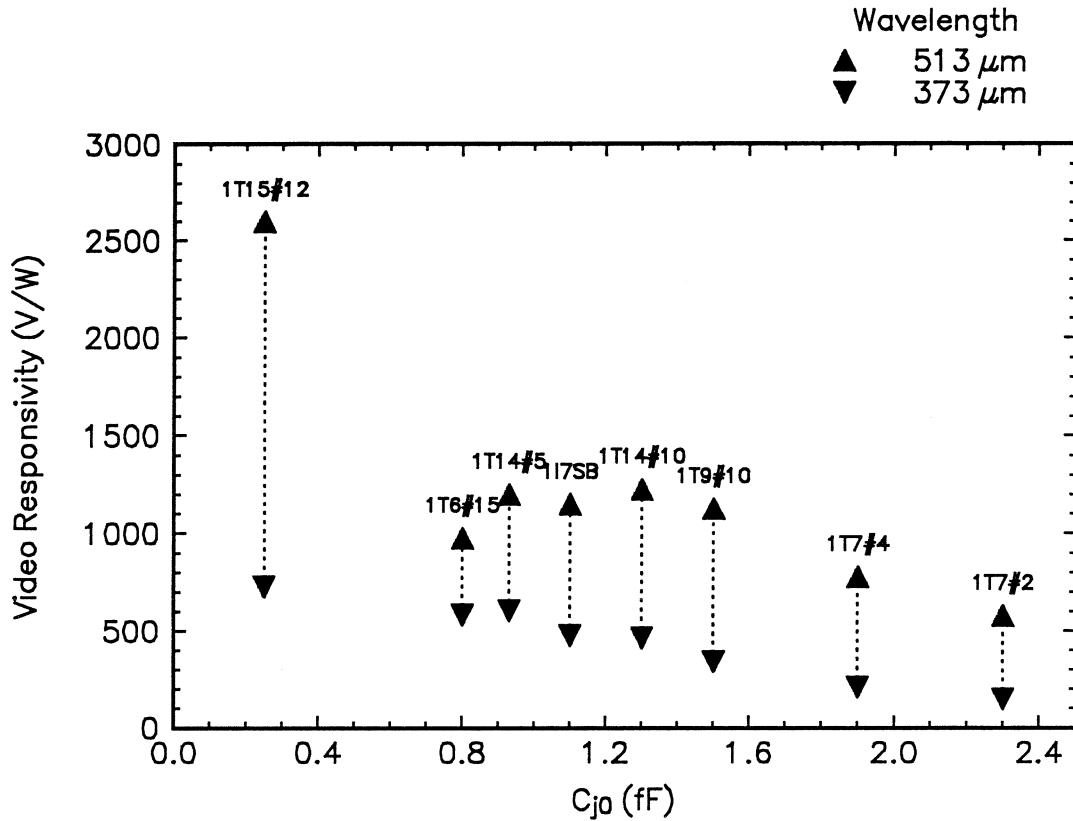

Fig. 4. Video responsivity versus zero bias junction capacitance, C_{j0} , at 585 GHz ($\lambda = 513 \mu\text{m}$) and 803 GHz ($\lambda = 373 \mu\text{m}$).

series resistance, R_s . R_j and R_s form a voltage divider and we ideally want all the voltage dropped across R_j , which requires either a small R_s or a large R_j . The junction capacitance, which shunts R_j , is the dominant parasitic element. The data shown in Fig. 4 was taken at a bias current of 1 μA . Our data does not indicate any difference in the video performance between the high doped diodes (1T14 and 1T15) and the low doped diodes, provided the capacitance is the same.

The noise measurements were performed using a hot-cold load. The hot load was room temperature Eccosorb AN-73 material. The cold load was AN-73 material submerged in liquid nitrogen. All measurements were made with the diode and the IF receiver at room temperature. The IF receiver had a noise temperature of 103K. No corrections for atmospheric absorption or diplexer loss were incorporated into the data.

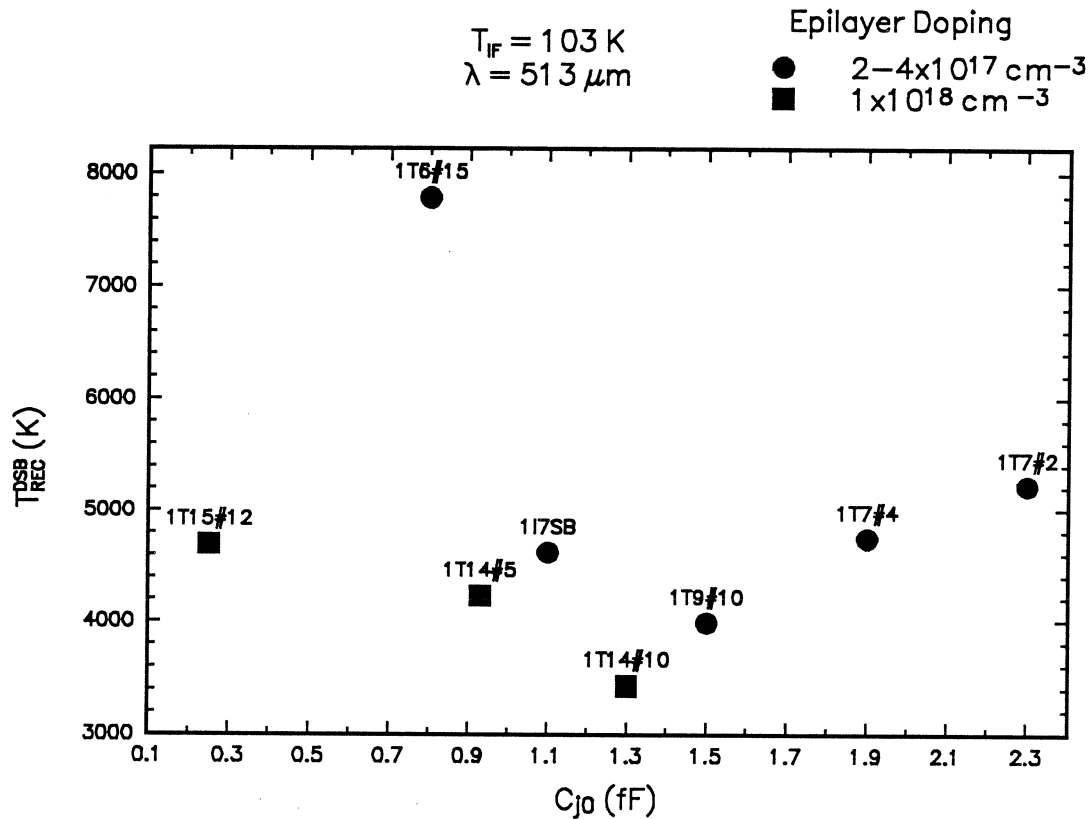

Fig. 5. Receiver noise temperature results at 585 GHz.

A summary of receiver noise temperatures is shown in Figs. 5, 6 and 7. The results for 585 GHz ($\lambda = 513 \mu\text{m}$) are shown in Fig 5. The lowest noise temperature was the high doped 1T14#10 with a receiver noise temperature (DSB)¹ of 3450K. For any given capacitance, the high doped diodes had a lower noise temperature than the low doped diodes. Both the high and low doped series of diodes yield a minimum noise temperature at one value of C_{j0} . At 585 GHz this minimum appears to be about 1.3 to 1.5 fF.

The results at 803 GHz ($\lambda = 373 \mu\text{m}$) are shown in Fig. 6. At 803 GHz the lowest receiver noise temperature was 3150K with the 1T14#5 diode. Once again, the high doped diodes have a lower noise temperature than the low doped diodes for a given capacitance. Also there is a

¹Double sideband temperatures and conversion losses will be used throughout this paper.

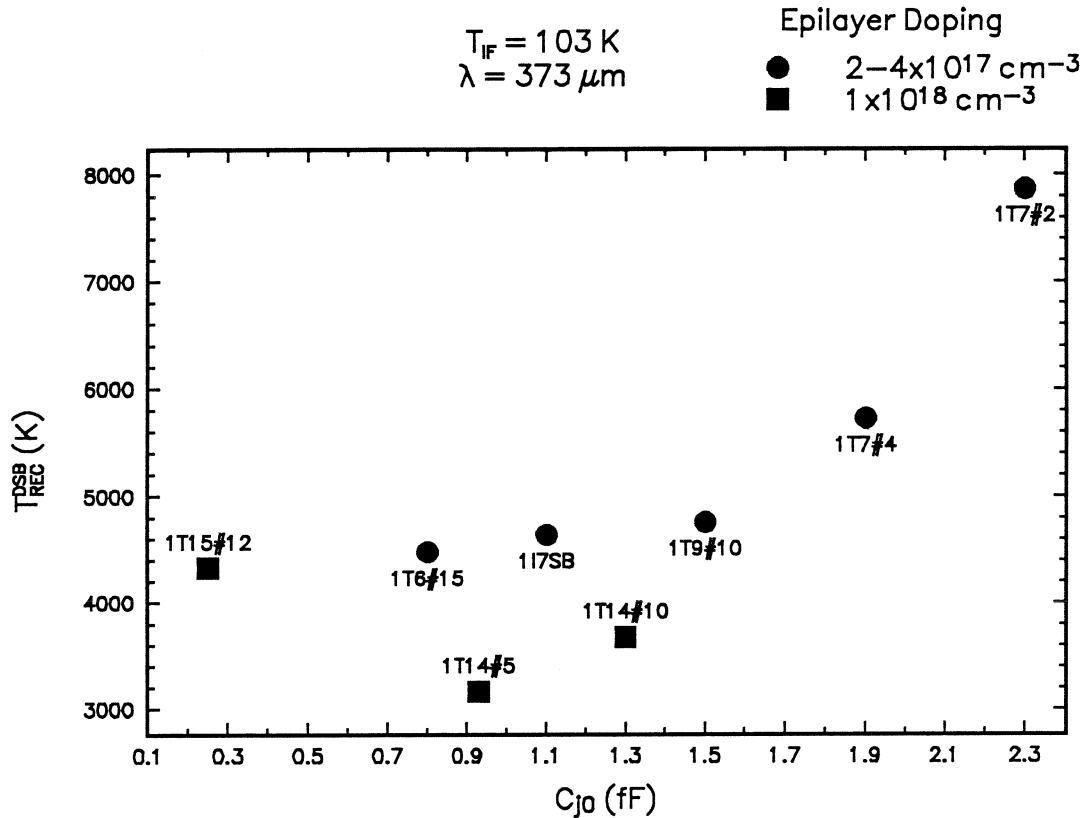

Fig. 6. Receiver noise temperature results at 803 GHz.

minimum in the receiver noise temperature versus C_{j0} at about 0.9 fF.

Receiver noise temperature versus frequency is plotted in Fig. 7 for select diodes. The best diodes at 585 and 803 GHz are the two 1T14 diodes. At 1.6 THz the 1T15#12 diode has the lowest receiver noise temperature.

IV. DISCUSSION

Crowe and Peatman [9] suggested that higher doping would lower the receiver noise temperature by decreasing the noise contribution of the diode. This noise comes from the conversion loss of the mixer and the from the diode's shot noise and hot-electron noise. To determine the contribution from all sources an analysis similar to that done by Harris [8] was

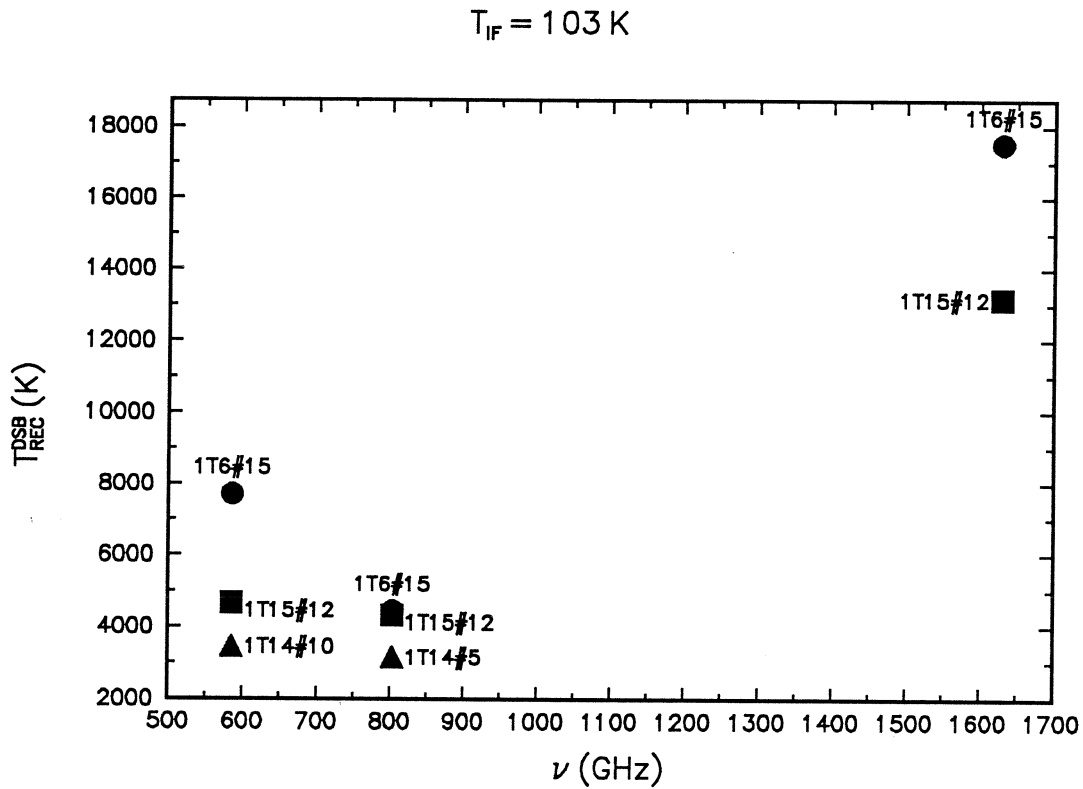

Fig. 7. Receiver noise temperature versus frequency for selected diodes.

carried out. A basic heterodyne receiver is shown in Fig. 8. The relationship between the measured mixer temperature, T'_M , measured mixer conversion loss, L'_M , and receiver temperature is given by;

$$T_{REC} = T'_M + L'_M T_{IF} \tag{1}$$

These terms include optical coupling efficiency into the corner cube, η_o , and the IF mismatch, Γ^2 , as shown in Fig. 8. Eqns. 2, 3 and 4 are used to extract the diode temperature from the measured data [8, 9].

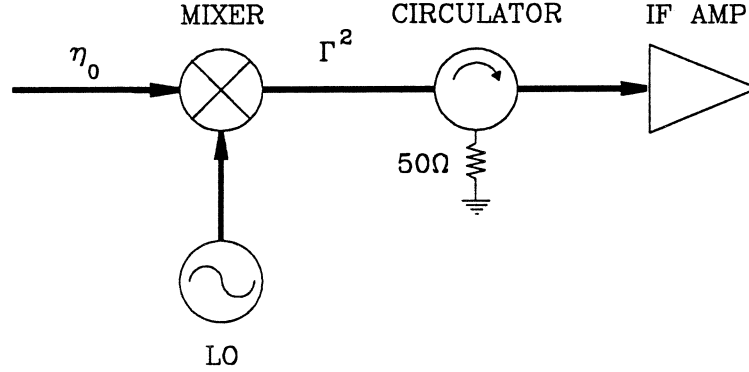

Fig. 8. A basic heterodyne receiver including the optical coupling efficiency, η_0 , and IF mismatch, Γ^2 . The load resistor of the circulator is at room temperature.

$$T'_M = L'_M \Gamma^2 T_{i,RJ} + \frac{T_M}{\eta_0} \quad (2)$$

$$L'_M = \frac{L_M}{\eta_0(1-\Gamma^2)} \quad (3)$$

$$T_M = (L_M - 1)T_{D,avg} \quad (4)$$

where T_M is the true mixer temperature, L_M is the true mixer conversion loss, $T_{i,RJ}$ is the temperature of the load resistor on the circulator (300K for this analysis) and $T_{D,avg}$ is the diode noise temperature averaged over an LO cycle.

The noise breakdown for each diode at 585 GHz and 803 GHz are summarized in Tables II and III. The tables are divided into two sections for high and low doped diodes. The optical coupling coefficient, η_0 , was assumed to be 0.5 for all calculations. Measurements with an HP8720C vector network analyzer of various diodes indicated that the SWR looking into the corner cube with impedance matching transformer was never more than 1.3. Therefore the reflection coefficient, Γ^2 , was assumed to be 0.017.

Table II. Summary of RF Performance at 585 GHz. All temperatures and conversion losses are double sideband.

Epilayer Doping (cm ⁻³)	Diode	Zero Bias C _{j0} (fF)	Receiver Noise T _{REC} (K)	Mixer Noise T _M ' (K)	Mixer Loss L _M ' (dB)	Minimum LO Power (mW)	Corrected Mixer Noise, T _M (K)	Corrected Mixer Loss, L _M (dB)	Diode Noise T _D (K)
2-4x10 ¹⁷	1T7#2	2.3	5200	4100	10.3	1.4	2050	7.2	480
	1T7#4	1.9	4750	3800	9.7	1.2	1900	6.6	515
	1T9#10	1.5	4000	3150	9.0	0.6	1550	5.9	545
	1I7SB	1.1	4600	3600	9.8	0.7	1800	6.8	480
	1T6#15	0.8	7800	6200	11.9	0.4	3050	8.7	455
10 ¹⁸	1T14#10	1.3	3450	2750	8.3	1.0	1350	5.2	580
	1T14#5	0.93	4250	3350	9.4	0.7	1650	6.3	500
	1T15#12	0.25	4700	3750	9.5	0.3	1850	6.4	550

The high doped diodes have a lower receiver noise temperature than the comparable capacitance low doped diodes. Comparing the diode noise, T_D , the high doped diodes perform similarly to the low doped diodes for a given capacitance. The conversion loss, however, is lower for the high doped diodes and this appears to be have resulted in the improved receiver noise temperature. Our primary goal in producing diodes with higher epitaxial layer doping density was to reduce the receiver noise by increasing the current at which hot-electron noise became important. The idea was that such diodes could be used in a shot-noise-limited mode (unaffected by hot-electron noise) and the average diode noise temperature would be the diode shot noise temperature, given by $T_{\text{shot}} = \eta T/2$. Thus, even though the higher doping increases the shot noise temperature by increasing η , the elimination of hot electron noise would drastically improve performance. In actuality, we have found that the average diode temperature has remained virtually constant, while the mixer conversion loss has been decreased.

To understand this discrepancy, it is important to realize that the mixer bias and LO power are adjusted to achieve the lowest possible receiver temperature. There is always a direct trade-off between mixer conversion loss and diode noise. As the bias current and LO power are increased, the conversion loss is decreased (the diode is pumped harder). However, at some point the diode

Table III. Summary of RF Performance at 803 GHz. All temperatures and conversion losses are double sideband.

Epilayer Doping (cm ⁻³)	Diode	Zero Bias C _{j0} (fF)	Receiver Noise T _{REC} (K)	Mixer Noise T _M ' (K)	Mixer Loss L _M ' (dB)	Minimum LO Power (mW)	Corrected Mixer Noise, T _M (K)	Corrected Mixer Loss, L _M (dB)	Diode Noise T _D (K)
2-4x10 ¹⁷	1T7#2	2.3	7850	6250	12	2.0	3100	8.9	455
	1T7#4	1.9	5750	4600	10.5	1.9	2250	7.4	505
	1T9#10	1.5	4750	3800	9.7	1.4	1900	6.6	530
	1I7SB	1.1	4650	3650	9.8	1.0	1800	6.8	480
	1T6#15	0.8	4500	3500	9.8	0.5	1700	6.7	470
10 ¹⁸	1T14#10	1.3	3650	2900	8.6	1.3	1450	5.5	560
	1T14#5	0.93	3150	2450	8.4	1.1	1200	5.3	510
	1T15#12	0.25	4350	3350	9.8	0.2	1650	6.7	440

noise temperature begins to increase due to the hot-electron noise. Beyond the optimum point the increase in diode noise outweighs the benefit of lower conversion loss, and the total receiver sensitivity is degraded. It is our belief that the new higher doped diodes achieve greater sensitivity because they can be pumped to a lower conversion loss before the increase in the diode's hot-electron noise becomes the dominating factor.

V. SUMMARY

Schottky diodes are currently the most sensitive mixers available for frequencies in the terahertz range, but more sensitive receivers will be required for future NASA missions. For this reason we have investigated improvements that will lower the noise temperature of the diode mixer. These improvements have centered on decreasing the anode diameter and increasing the epitaxial layer doping.

Diodes with an epitaxial layer doping of 10¹⁸ cm⁻³ were fabricated. Contact lithography and a UV light source were used for anode diameters greater than 0.5 μm. Direct-write electron beam

lithography, performed at the National Nanofabrication Facility at Cornell University, was needed to create 0.25 μm anode diameters.

In going to a higher epitaxial layer doping we have attempted to achieve shot-noise-limited performance for the mixer. We measured the receiver noise temperature for several diodes with varying capacitance and epitaxial layer doping densities. The high doped diodes had the lowest receiver noise temperatures for a given junction capacitance. The 1T14 diode, with a 0.5 μm anode diameter, achieved a minimum double sideband receiver noise temperature of 3450K at 585 GHz and 3150K at 803 GHz. The 1T15 diode, with a 0.25 μm anode diameter, had a double sideband receiver noise temperature of 13150K at 1.63 THz. The high doped diodes had about the same diode noise temperature as low doped diodes, but the conversion loss was less. The increased doping density allowed the new diodes to be operated at a higher bias current, thereby decreasing the conversion loss without increasing the diode noise temperature.

VI. ACKNOWLEDGEMENTS

This work has been supported by the National Science Foundation (ECS-9113123) and the U.S. Army Foreign Science Technology Center (DAHC90-91-C-0030).

VII. REFERENCES

- [1] J.W. Waters and P.H. Siegel, "Applications of Millimeter and Submillimeter Technology to Earth's Upper Atmosphere: Results To Date and Potential for the Future," Fourth International Symposium on Space THz Technology, Los Angeles, CA, March 1993.
- [2] M.A. Frerking, "The Submillimeter Mission Heterodyne Instrument," The Second International Symposium on Space THz Technology Proc., Pasadena, CA, pp. 17-31, Feb. 1991.
- [3] J. Hernichel, R. Schieder, J. Stutzki, B. Vowinkel, G. Winnewisser, and P. Zimmermann, "A 492 GHz Cooled Schottky Receiver for Radio Astronomy," Proceedings Third Intl. Symp. Space Terahertz Tech., Ann Arbor, MI, pp. 724-730, March 1992.
- [4] C.K. Walker, J.W. Kooi, M. Chan, H.G. LeDuc, P.L. Schaffer, J.E. Carlstrom, T.G. Phillips, "A Low Noise 492 GHz SIS Waveguide Receiver," Third International Symposium on Space THz Technology Proceedings, Ann Arbor, MI, pp. 266-279, March 1992.

- [5] G. De Lange, C.E. Honingh, M.M.T.M. Dierichs, R.A. Panhuyzen, H.H.A. Schaefer, T.M. Klapwijk, H. Van De Stadt, M.W.M. De Grauw, "A Low Noise 410-495 Heterodyne Two Tuner Mixer, Using Submicron Nb/Al₂O₃/Nb Tunneljunctions," Proceedings Third Intl. Symp. Space Terahertz Tech., Ann Arbor, MI, pp. 210-233, March 1992.
- [6] S. Weinreb and A.R. Kerr, "Cryogenic Cooling of Mixers for Millimeter and Submillimeter Wavelengths," IEEE J. Solid State Circuits, Vol. SC-8, pp. 58-63, Feb. 1973.
- [7] C.R. Predmore, A.R. Räisänen, N.R. Erickson, P.F. Goldsmith, and J.L.R. Marrero, "A Broad-Band, Ultra-Low-Noise Schottky Diode Mixer Receiver for 80 to 115 GHz," IEEE Trans. Microwave Theory Tech., Vol. MTT-32, pp. 498-506, May 1984.
- [8] A.I. Harris, J. Stutzki, U.U. Graf, and R. Genzel, "Measured Mixer Noise Temperature and Conversion Loss of a Cryogenic Schottky Diode Mixer Near 800 GHz," Intl. J. Infrared and Millimeter Waves, Vol. 10, No. 11, Nov. 1989.
- [9] T.W. Crowe and W.C.B. Peatman, "GaAs Schottky Barrier Diodes for Space Based Applications at Submillimeter Wavelengths," The 2nd Int'l. Symp. Space THz Tech. Proc., Pasadena, CA, Feb. 1991.
- [10] U.V. Bhapkar and T.W. Crowe, "Analysis of the High Frequency Series Impedance of GaAs Schottky Diodes by a Finite Difference Technique," IEEE Trans. Microwave Theory Tech., Vol. 40, No. 5, pp. 886-894, May 1992.
- [11] D.T. Young and J.C. Irvin, "Millimeter Frequency Conversion Using Au-n-Type GaAs Schottky Barrier Epitaxial Diodes with a Novel Contacting Technique," Proc. IEEE, pp. 2130-2131, Dec. 1965.
- [12] T.W. Crowe, R.J. Mattauch, H.P. Röser, W.L. Bishop, W.C.B. Peatman, "GaAs Schottky Diodes for THz Mixing Application," Invited paper, Proc. of the IEEE, Special Issue on Terahertz Technology, Vol. 80, No. 11, Nov. 1992.
- [13] W.C.B. Peatman and T.W. Crowe, "Design and Fabrication of 0.5 micron GaAs Schottky Barrier Diodes for Low-Noise Terahertz Receiver Applications," Int. Journal on Infrared and Millimeter Waves, Vol. 11, No. 3, pp. 355-365, 1990.
- [14] P.A. Verlangieri and M.V. Schneider. "Microfabrication of GaAs Schottky barrier diodes for multipliers, mixers and modulators," Int. J. of IR and MM Waves, Vol. 6, pp. 1191-1202, 1985.