



Improving the Security of Medical Devices

Kevin Fu

Associate Professor

Security & Privacy Research Lab

UMass Amherst Computer Science

<http://spqr.cs.umass.edu/>

IFIP 10.4 WG, Rockport, MA June 29, 2012



Supported in part by a Sloan Research Fellowship, NSF CNS-0831244, HHS 90TR0003/01.

Any opinions, findings, and conclusions expressed in this material are those of the authors and do not necessarily reflect the views of the NSF.

Acknowledgments

- CS faculty and physicians
 - Prof. Dina Katabi, MIT Computer Science and AI Lab
 - Prof. **Tadayoshi Kohno**, University of Washington CSE
 - Dr. Daniel Kramer, BIDMC, Harvard Med School
 - Dr. William Maisel, BIDMC, Harvard Med School (fmr)
 - Dr. Matthew Reynolds, BIDMC, Harvard Med School
 - Prof. Dawn Song, UC Berkeley Computer Science Div.
- Research assistants
 - Shane Clark, Benessa Defend, **Tamara Denning**, Shyamnath Gollakota, Dan Halperin, Steve Hanna, Haitham Hassanieh, Tom Heydt-Benjamin, Andres Molina-Markham, Will Morgan, Pongsin Poosankam, Ben Ransford, Rolf Rolles, Mastooreh Salajegheh, Quinn Stewart



- Cybersecurity
 - Medical devices, RFID
- Stochastic computing
 - Rethinking HW-SW interfaces to reduce energy
 - Probabilistic storage in low-voltage NOR flash
 - Zero-power clocks for smartcards

Today's slice
of research

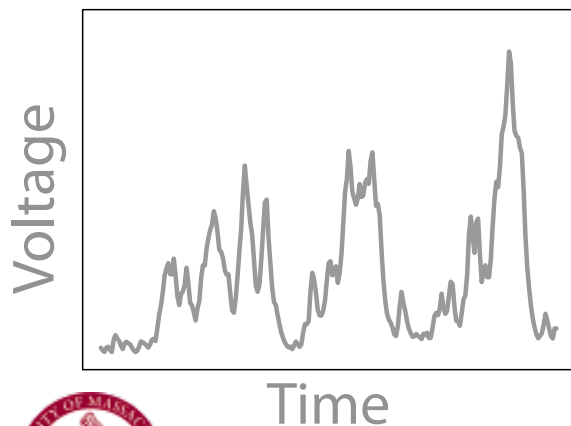
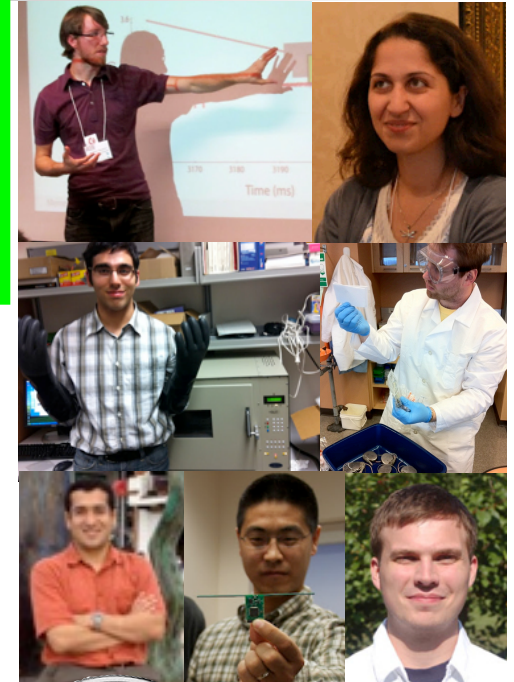

Disclosures

- Support from NSF, HHS, DHS, IOM, Microsoft Research, Symantec, McAfee
- Visiting scientist, FDA
- Board member, NIST ISPAB
- Patent pending technology:
 - Ultra-low power flash memory
 - Zero-power security
- This presentation is based on both my own research and the research of others. None of the opinions, findings, or conclusions necessarily reflect the views of my past or present employers.



Hat: zazzle.com



Accumulative Risks of...

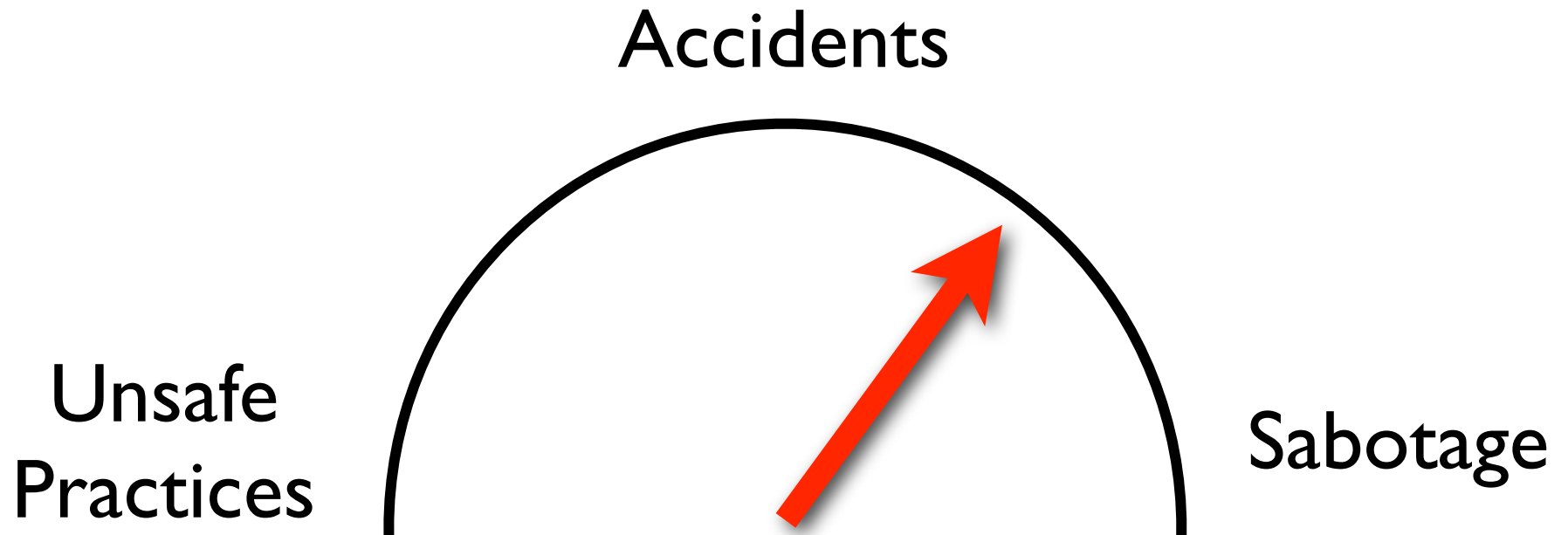

Threat-o-meter



Managerial issues: Diffusion of responsibility



Dirty Secrets: SW Maintenance

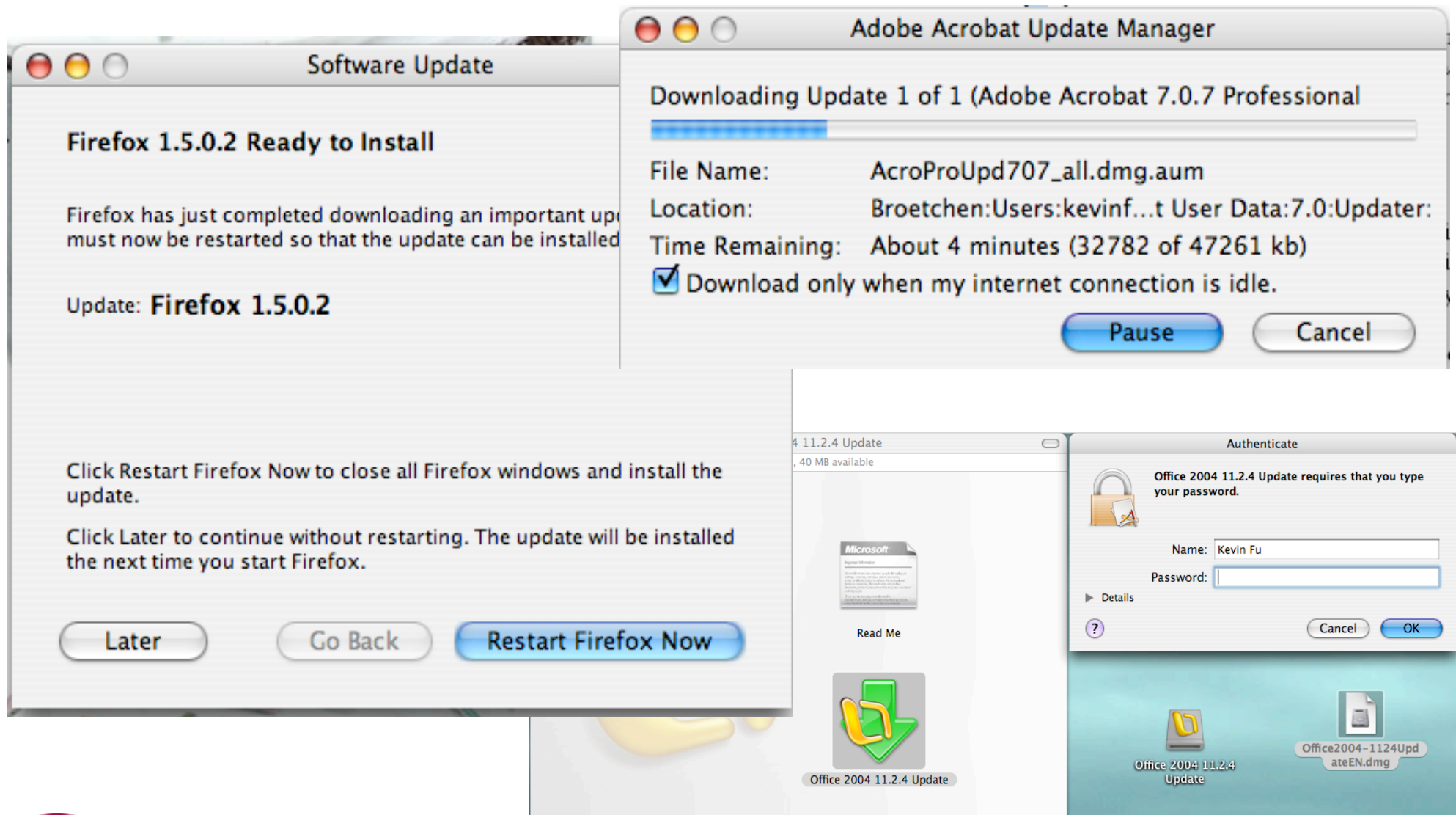

Secure Software Updates: Disappointments and New Challenges

Anthony Bellissimo, John Burgess, Kevin Fu

{*twon, jburgess, kevinfu*}@cs.umass.edu

Department of Computer Science, University of Massachusetts Amherst

<http://prisms.cs.umass.edu/>

Abstract

A client can use a content distribution network to securely download software updates. These updates help to patch everyday bugs, plug security vulnerabilities, and secure critical infrastructure. Yet challenges remain for secure content distribution: many deployed software update mechanisms are insecure, and emerging technologies pose further hurdles for deployment. Our analysis of several popular software update mechanisms shows that deployed systems often rely on trusted networks to distribute critical software updates — despite the research progress in secure content distribution. We demonstrate how many deployed systems are susceptible to weak man-in-the-middle attacks. Furthermore, emerging technologies such as mobile devices, sensors, medical devices, and RFID tags present new challenges for secure software updates. Sporadic network connectivity and limited power, computation, and storage require a re-thinking of traditional approaches for secure content distribution on embedded devices.

1 Introduction

Every day, millions of computer users update software — some manually, some automatically, and some unknowingly. Indeed, 69 of the last 71 CERT Technical Cyber Security Alerts¹ suggest applying patches, upgrades, or updates to resolve security vulnerabilities [33]. Corporations reportedly spent more than \$2 billion in 2002 on patch management for operating systems alone [3]. Surprisingly, many deployed systems do not make use of well-understood techniques from secure content distribution (Table 1).

At the same time, emerging technologies such as mobile devices, sensors, and RFID tags sporadically connect to the edge of the Internet. These emerging technologies bring additional challenges for securely updating embedded software. For instance, the FDA has

¹To appear at the USENIX Hot Topics in Security Workshop (HotSec), July 2006, Vancouver, Canada.

²Two of the 71 alerts do not suggest applying updates because updates were not yet available.

recently relaxed rules on embedded software in medical devices [11, 13]. The design requirements are now less stringent for mechanical/electrical failsafes to act as backups to software. One implantable infusion pump resulted in two overdose deaths and several injuries because the software in the wireless programmer allowed a clinician to transpose the hours and minutes field [5]. While it is a challenge to design user interfaces to prevent accidents, even a sound user interface will not prevent malicious updates generated by a wireless adversary.

We first report on the state of the art in secure automatic updates. The results are disappointing. Many software update mechanisms lack basic security measures such as verification of digital signatures. Left open and unprotected, these update channels serve as an ideal backdoor for spreading malicious code.

Embedded devices such as mobile phones, sensors, medical implants, and advanced RFID tags increasingly run more sophisticated software. One could apply techniques from secure content distribution for updating software on these new technologies. However, traditional approaches in secure content distribution often assume a well-connected network or a well-provisioned client. Thus, we enumerate several of the new challenges for updating software on embedded devices.

2 Survey of Deployed Update Systems

We begin by analyzing the resistance of several existing software update systems to man-in-the-middle attacks (MITM). Surprisingly, several systems lack protection against weak MITM attacks (Table 1).

Apple MacOS Software Update. Apple signs its binary updates to ensure software integrity and authenticity. Each update includes a file named “signature” containing a 1,024-byte signature of the hash of the accompanying installation executable. Each installation binary is checked against its signature which may only be signed by the private key held by Apple Computer Corp. (whose public key is included on the operating system’s installation media). No encrypted connections are needed, nor



HotSec '06
1st USENIX Workshop on Hot Topics in Security

Software Update Woes

- Health Information Technology (HIT) devices globally rendered unavailable
- Cause: Automated software update went haywire
- Numerous hospitals were affected April 21, 2010
 - Rhode Island: a third of the hospitals were forced to postpone elective surgeries and stop treating patients without traumas in emergency rooms."
 - Upstate University Hospital in New York: 2,500 of the 6,000 computers were affected.

THE VANCOUVER SUN

Web-security giant McAfee paralyzes computers at hospitals, universities worldwide with update



Users are Helpless

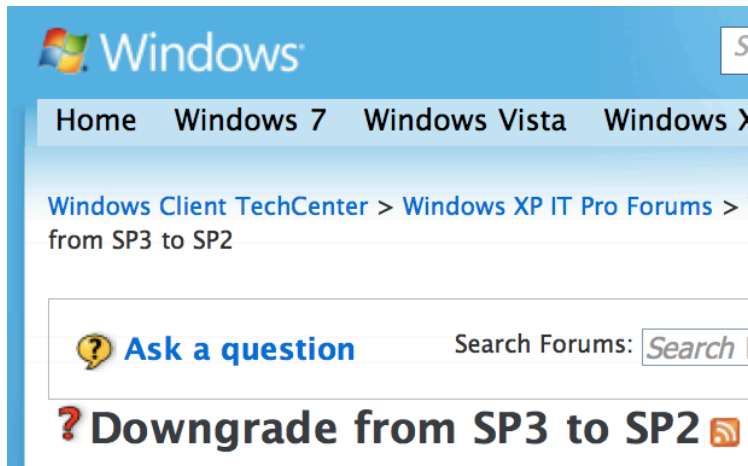

Windows

Home Windows 7 Windows Vista Windows X

Windows Client TechCenter > Windows XP IT Pro Forums > from SP3 to SP2

Ask a question Search Forums: Search

? Downgrade from SP3 to SP2

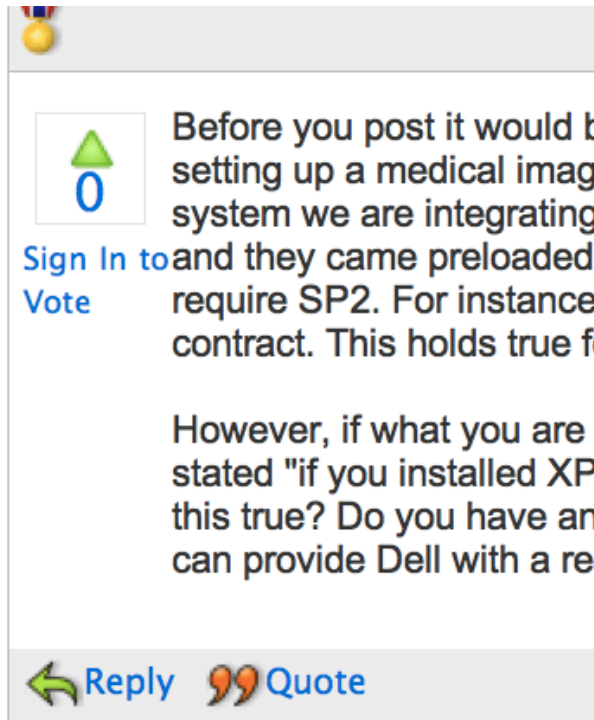

0

Sign In to Vote

Before you post it would be setting up a medical imaging system we are integrating and they came preloaded require SP2. For instance contract. This holds true for

However, if what you are stated "if you installed XP this true? Do you have an can provide Dell with a reason why I need to order downgraded XP discs.

Reply Quote



Slashdot NEWS FOR NERDS. STUFF THAT MATTERS.

Stories Recent Popular Search

Technology: Windows XP SP2 Support Ends Tomorrow

Posted by CmdrTaco on Monday July 12, @09:37AM from the better-get-patching dept.

Vectormatic writes

"As can be seen on the product page for Windows XP, support for SP2 ends tomorrow, while the majority of Windows XP users still haven't upgraded to SP3. This could open up millions of users/businesses to exploitation, since security updates for SP2 will stop coming in while security fixes to SP3 may clue hackers in to vulnerabilities."



Still Not It: Hospitals, Manufacturers



U.S. Department of Health & Human Services

www.hhs.gov

FDA U.S. Food and Drug Administration

A-Z Index

Search

go

[Home](#) | [Food](#) | [Drugs](#) | [Medical Devices](#) | [Vaccines, Blood & Biologics](#) | [Animal & Veterinary](#) | [Cosmetics](#) | [Radiation-Emitting Products](#) | [Tobacco Products](#)

Medical Devices

[+ Share](#) [✉ Email this Page](#) [🖨 Print this page](#) [⊕ ⊖ Change Font Size](#)

[Home](#) > [Medical Devices](#) > [Medical Device Safety](#) > [Alerts and Notices \(Medical Devices\)](#)

Medical Device Safety

Alerts and Notices (Medical Devices)

[Information About Heparin](#)

[Luer Misconnections](#)

[Safety Communications](#)

[Public Health Notifications \(Medical Devices\)](#)

[Tips and Articles on Device Safety](#)

[Patient Alerts \(Medical Devices\)](#)

Reminder from FDA: Cybersecurity for Networked Medical Devices is a Shared Responsibility

Issued

November 4, 2009

For

Medical device manufacturers, hospitals, medical device user facilities, healthcare IT and procurement staff, medical device users, biomedical engineers

Issue

FDA wants to remind you that cybersecurity for medical devices and their associated communication networks is a shared responsibility between medical device manufacturers and medical device user facilities. The proper maintenance of cybersecurity for medical devices and hospital networks is vitally important to public health because it ensures the integrity of the computer networks that support medical devices.

FDA is aware of misinterpretation of the regulations for the cybersecurity of medical devices that are connected to computer networks. FDA's interpretation of the regulations can be found in the 2005 [guidance](#) for industry and its accompanying [information for healthcare organizations](#).



Managerial issues: Diffusion of responsibility

Who's covered when
Secure Health IT hits the fan?



Accumulative Risks of...

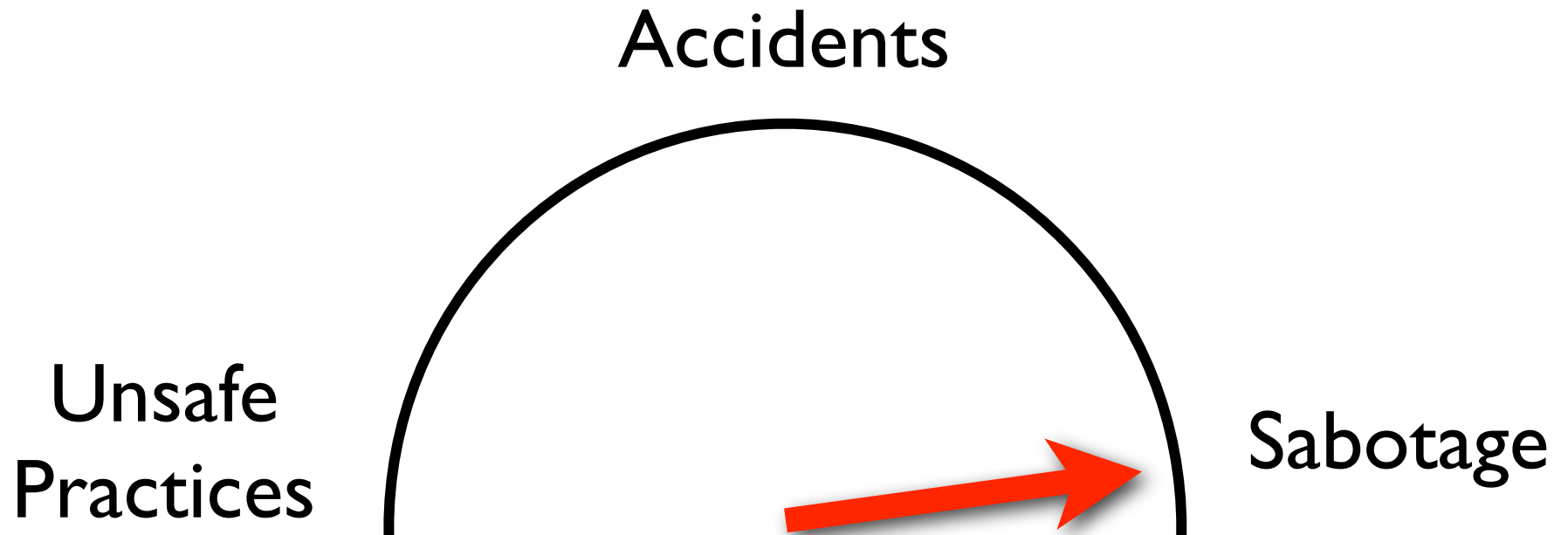

Threat-o-meter



Security Analysis

1. Vulnerabilities
2. Threats
3. Exploits



Benefits of Wireless



Photo by Kevin Fu @ Medtronic museum



Implantation of Defibrillator

1. Doctor sets patient info
2. Surgically implants
3. Tests defibrillation
4. Ongoing monitoring



Device Programmer
Home monitor



Photos: Medtronic; Video: or-live.com

Wirelessly Induce Fatal Heart Rhythm

- 402-405 MHz MICS band, nominal range several meters
- Command shock sends 35 J in ~ 1 msec to the T-wave
- Designed to induce ventricular fibrillation
- No RF amplification necessary



[Halperin et al., IEEE Symposium on Security & Privacy 2008]





Print



Tweet



Like

31

Insulin pump hack delivers fatal dosage over the air **Sugar Blues, James Bond style**

By [Dan Goodin in San Francisco](#) • [Get more from this author](#)

Posted in [Security](#), 27th October 2011 06:23 GMT

In a hack fitting of a James Bond movie, a security researcher has devised a way to hijack nearby insulin pumps, enabling him to surreptitiously deliver fatal dosages to patients who rely on them.

Wireless medical devices:
great benefits.
subtle inconvenient risks.



Wireless Makes Everything Better?



Eliminative
induction: variety of
reasons for doubt
(Baconian thinking)
- John Goodenough



What about **Internet**-related risks?



"These days, everything is much safer. It is easier to navigate thanks to modern technical instruments and the Internet."

-Captain Schettino, Captain of Costa Concordia



Medical device security **threats?**



Achoo!



The Weekly World News:
world's only reliable journal



Viruses on Radiology Equipment?

“over 122 medical devices have been compromised by malware over the last 14 months”

Statement of The Honorable Roger W. Baker

[House Committee on Veterans' Affairs, Subcommittee on Oversight and Investigations, Hearing on Assessing Information Security at the U.S. Department of Veterans Affairs]

MAUDE Adverse Event Report



[510\(k\)](#) | [Registration & Listing](#) | [Adverse Events](#) | [Recalls](#) | [PMA](#) | [Classification](#) | [Standards](#)
[CFR Title 21](#) | [Radiation-Emitting Products](#) | [X-Ray Assembler](#) | [Medsun Reports](#) | [CLIA](#)

FUJIFILM MEDICAL SYSTEM USA, INC. IIP COMPUTED RADIOGRAPHY READER AND WORKSTATION

[Back to Search Results](#)

Model Number IIP

Event Date 06/13/2009

Event Type Malfunction

Event Description

Delay in treatment related to equipment failure on 4 patients. The images were frozen on the list and would not transmit on the fuji reader equipment. The system was rebooted without change. A few hours later the system was again shut down and rebooted and the images then did transfer. Images were repeated on equipment in another department. The next day the same issue occurred with 4 more patients and the system was shut down to await evaluation by the manufacturer. This problem was traced to a computer virus (conficker) which was found to be affecting 6 fuji cr units. The hospital's imaging service engineer applied a microsoft patch (ms08-067) to the 6 fuji units to prevent the virus from re-infecting the systems. Subsequent to this problem one of the fuji units experienced a shutdown, which was repaired by replacement of a defective power supply. This failure is not thought to be related to the virus issue.



Security of 156 VA Med. Centers

- Every **8 seconds**, the VA found usernames and **passwords** unprotected on networks
- VA has **~600,000** connected computing devices, of which **~50,000** are considered medical devices
- VA implemented VLANs with **3,270 different ACLs**
- Manual maintenance of ACLs prone to human error
- ACLs broke network security tools that detect intrusions
- Why? My opinion: Unable to procure medical devices that provide meaningful security



Disease to Malware: Days to Hours

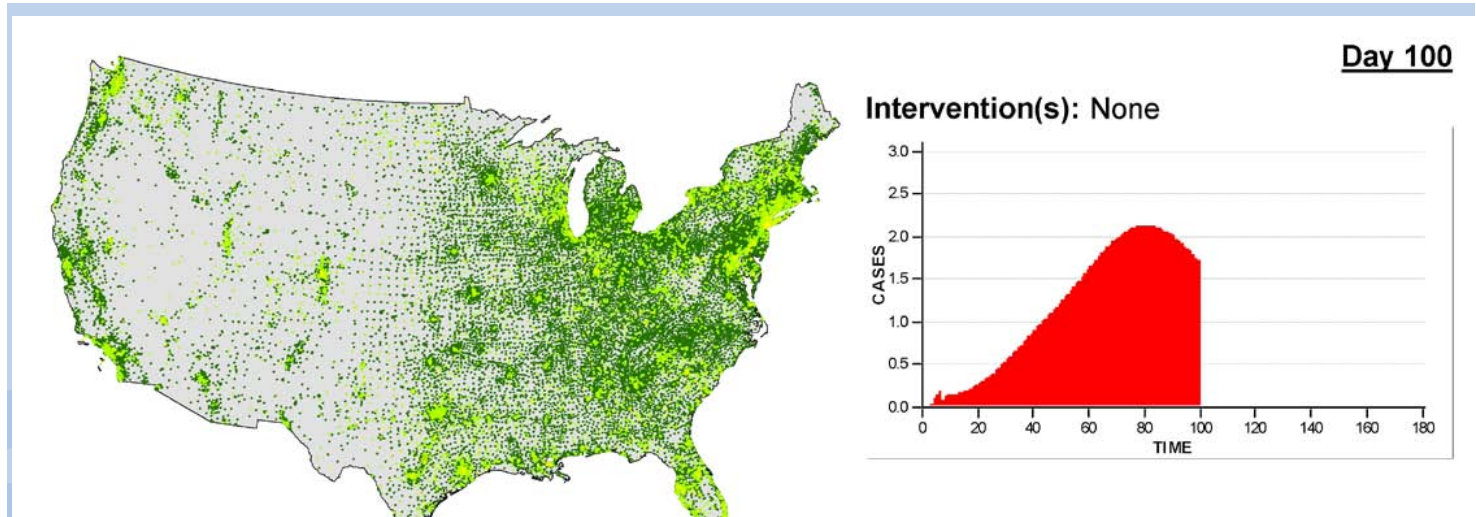

Dark Clouds on the Horizon:
The Network is a *Vulnerability Amplifier*

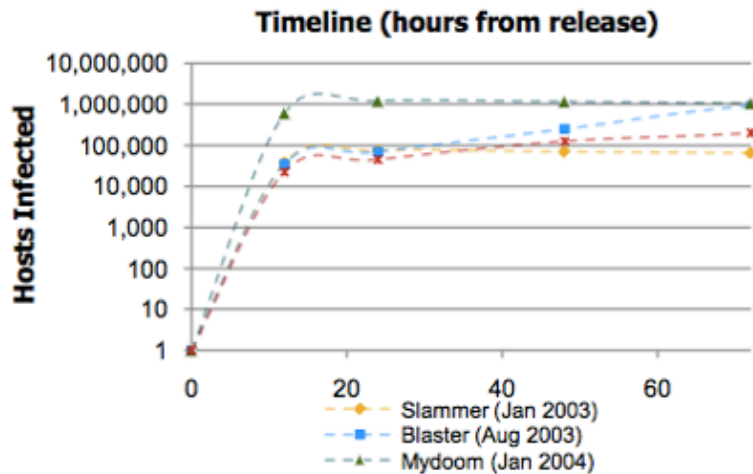

How significant are
intentional,
malicious
malfunctions
in software?



21 CFR 211.132 and Security

TITLE 21--FOOD AND DRUGS
CHAPTER I--FOOD AND DRUG ADMINISTRATION
DEPARTMENT OF HEALTH AND HUMAN SERVICES
SUBCHAPTER C--DRUGS: GENERAL

PART 211 -- CURRENT GOOD MANUFACTURING PRACTICE FOR FINISHED PHARMACEUTICALS

Subpart G--Packaging and Labeling Control

Sec. 211.132 Tamper-evident packaging requirements for over-the-counter (OTC) human drug products.

(a)General. The Food and Drug Administration has the authority under the Federal Food, Drug, and Cosmetic Act (the act) to establish a uniform national requirement for tamper-evident packaging of OTC drug products that will **improve the security** of OTC drug packaging



The Tylenol Scare of 1982

The Tylenol Terrorist

Print Email SHARE

T Smaller | Larger

By Rachael Bell

The Tylenol Terrorist: Death in a Bottle



Extra-Strength Tylenol package

On September 29, 1982, 12-year-old Mary Kellerman of Elk Grove Village, Illinois, woke up at dawn and went into her parents' bedroom. She did not feel well and complained of having a sore throat and a runny nose. To ease her discomfort, her parents gave her one Extra-Strength Tylenol capsule. At 7 a.m. they found Mary on the bathroom floor. She was immediately taken to the hospital where she was later pronounced dead. Doctors initially suspected that Mary died from a stroke, but evidence later pointed to a more sinister diagnosis.

[Source: truTV crime library]

Fatal tampering case is renewed

FBI searches a condo in Cambridge



FBI agents carrying items seized from an apartment building on Gore Street in Cambridge walked out before a phalanx of television photographers. Five boxes and a computer were removed, but the FBI would not comment on their contents. (JIM DAVIS/GLOBE STAFF)

February 5, 2009

Email Print Single Page Yahoo! Buzz ShareThis

Text size - +

This story was reported by Jonathan Saltzman, John R. Ellement, Milton J. Valencia, and David Abel of the Globe staff. It was written by Saltzman.

Discuss COMMENTS (5)

CAMBRIDGE -- FBI agents and State Police investigators searched a Cambridge condominium yesterday that is the longtime home of a leading suspect in the 1982 deaths of seven people from cyanide-laced Tylenol capsules in the Chicago area, one of the most notorious unsolved crimes in the last generation.



Bad People Do Exist: Vandals

Hackers Assault Epilepsy Patients via Computer

By Kevin Poulsen  03.28.08 | 8:00 PM

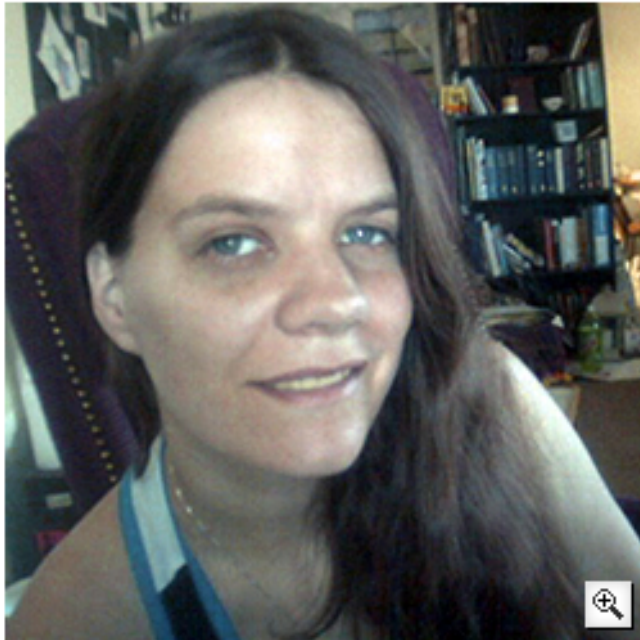

RyAnne Fultz, 33, says she suffered her worst epileptic attack in a year after she clicked on the wrong post at a forum run by the nonprofit Epilepsy Foundation. *Photo courtesy RyAnne Fultz*

Internet griefers descended on an epilepsy support message board last weekend and used JavaScript code and flashing computer animation to trigger migraine headaches and seizures in some users.

The nonprofit [Epilepsy Foundation](#), which runs the forum, briefly closed the site Sunday to purge the offending messages and to boost security.

"We are seeing people affected," says Ken Lowenberg, senior director of web and print publishing at the Epilepsy Foundation. "It's fortunately only a handful. It's possible that people are just not reporting yet -- people affected by it may not be coming back to the forum so fast."

The incident, possibly the first computer attack to inflict physical harm on the victims, began Saturday, March 22, when attackers used a script to post hundreds of messages embedded with flashing animated gifs.

The attackers turned to a more effective tactic on Sunday, injecting JavaScript into some posts that redirected users' browsers to a page with a more complex image designed to trigger seizures in both photosensitive and pattern-sensitive epileptics.



Lack of Exploits is Not Assurance

Pre-April 2012:
No Mac threats,
therefore never will be.

SECURITY | 4/20/2012 @ 5:28PM | 2,173 views

Antivirus Researchers Confirm:
Flashback Still Infects More
Than 500,000 Macs

Source: Andy Greenberg, Forbes

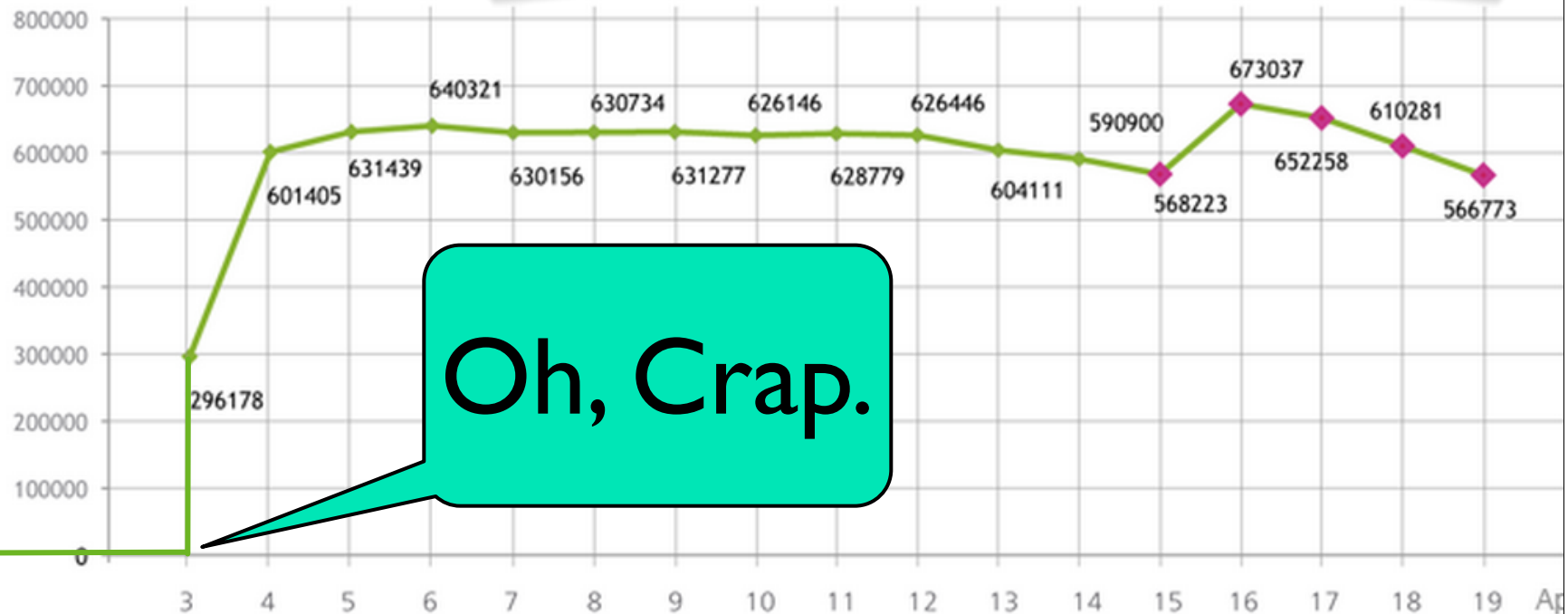

Oh, Crap.

Malware rarely
has precursor

19 Days in April 2012



Information Assurance Bliss?

"This is an evolution from having to **think about security and safety** as a healthcare company, and really about keeping people safe on our therapy, to this different question about keeping people safe around criminal or malicious intent."

[Catherine Szyman, President,
Medtronic diabetes division,
Reuters, October 26, 2011]



Shoot P0wn Foot w/ Software Update

The screenshot shows a web browser window with the URL <http://www.carefusion.com/customer-support/us-support/support-ventilation.aspx>. The browser's address bar also shows a "Suspected Malware Site" warning. The CareFusion logo is visible at the top left, and navigation links for Newsroom, Careers, Ordering, Login, and United States are at the top right. A search bar is located below the navigation. The main navigation menu includes "OUR SOLUTIONS", "OUR PRODUCTS", "CUSTOMER SUPPORT", "SAFETY & CLINICAL EXCELLENCE", "INVESTORS", and "OUR COMPANY". The "CUSTOMER SUPPORT" menu item is active. The breadcrumb trail reads "Home > Customer Support > U.S. > Product Support - Ventilation". The page content is divided into a left sidebar and a main content area. The sidebar contains an "Overview" section with links for Alerts and Notices, Contact Sales, Customer Support - Global, Customer Support - U.S., Ordering, and Product Training. Below this is a "Get Informed" section with links for Our Brands and Our Catalogs. The main content area features a "Product Support" heading, followed by "Ventilation" and a paragraph stating CareFusion's commitment to customer experience. It then lists technical support information for various brands, including AVEA, Bird, EnVe, ReVel, Stellar, LTV, SensorMedics, VELA, and VIASYS. Contact details for technical support are provided, including phone numbers, email addresses, and hours of operation. A section for HFOV and SIPAP support is also included, along with HFOV Rental information. At the bottom, contact information for AVEA, VELA, and Bird Blenders is listed.



Shoot P0wn Foot w/ Software Update

The screenshot shows a web browser window with a navigation menu on the left and a main content area. The navigation menu includes links for Alerts and Notices, Contact Sales, Customer Support - Global, Customer Support - U.S., and Ordering. The main content area is titled "Product Support" and "Ventilation". A large red warning dialog box is overlaid on the page, with the following text:

Warning: Visiting this site may harm your computer

The website you are visiting appears to contain malware. Malware is malicious software that may harm your computer or otherwise operate without your consent. Your computer can be infected just by browsing to a site with malware, without any further action on your part.

For detailed information about problems found on this site, or a portion of this site, visit the Google Safe Browsing diagnostic page for www.viasyshealthcare.com.

At the bottom of the dialog box are two buttons: "Ignore Warning" and "Close Page".

Below the dialog box, the website content is partially visible, showing contact information for EnVe (Phone: 800.554.8933, Email: support.vent.us@carefusion.com), a "Catalogs" section with links for HFOV parts and supplies, and LTV parts and accessories, and a "Software updates" section with links for AVEA Ventilator software update, EnVe Ventilator software update, and VELA Ventilator software update.



Shoot P0wn Foot w/ Software Update

Safe Browsing

Diagnostic page for www.viasyshealthcare.com

Advisory provided by 

What is the current listing status for www.viasyshealthcare.com?

This site is not currently listed as suspicious.

Part of this site was listed for suspicious activity 1 time(s) over the past 90 days.

What happened when Google visited this site?

Of the 291 pages we tested on the site over the past 90 days, 19 page(s) resulted in malicious software being downloaded and installed without user consent. The last time Google visited this site was on 2012-06-24, and the last time suspicious content was found on this site was on 2012-06-13.

Malicious software includes 38 trojan(s), 3 scripting exploit(s).

Malicious software is hosted on 4 domain(s), including nikju.com/, lilupophilupop.com/, koklik.com/.

This site was hosted on 1 network(s) including [AS26651 \(CAREFUSION\)](#).

Has this site acted as an intermediary resulting in further distribution of malware?

Over the past 90 days, www.viasyshealthcare.com did not appear to function as an intermediary for the infection of any sites.

Has this site hosted malware?

No, this site has not hosted malicious software over the past 90 days.

Next steps:

- [Return to the previous page.](#)
- If you are the owner of this web site, you can request a review of your site using Google [Webmaster Tools](#). More information about the review process is available in Google's [Webmaster Help Center](#).

Updated 2 hours ago



[Photo: CareFusion], Niels Provos]



Phone: 800.231.2466, ext 1

Email: support.vent.us@carefusion.com

Power Analysis of Medical Devices

- Power analysis for good!
- Detect malware on medical devices that cannot run conventional anti-virus SW

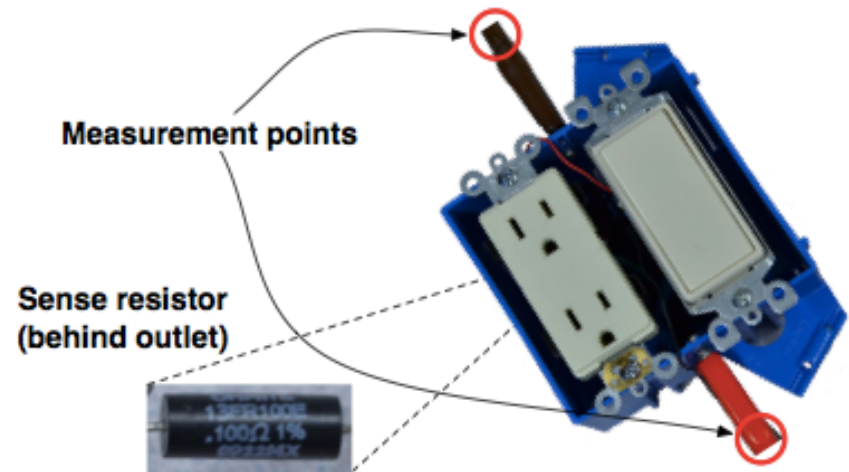

Figure 2: An instrumented AC outlet for capturing power traces. A data-acquisition unit connects to measurement points on either side of a 1 cm sense resistor.

- “Potentia est Scientia: Energy Proportionality Enables Whole-System Power Analysis” by Clark, Shane S., Ransford, Benjamin, and Fu, Kevin. In Proceedings of the 7th USENIX Workshop on Hot Topics in Security. August 2012. To appear.



Read More...

blog.secure-medicine.org
spqr.cs.umass.edu

**Security and Privacy Qualities of Medical Devices:
An Analysis of FDA Postmarket Surveillance.**

[Kramer, Daniel B.](#), [Baker, Matthew](#), [Ransford, Benjamin](#), [Molina-Markham, Andres](#), [Stewart, Quinn](#),
[Fu, Kevin](#), and [Reynolds, Matthew R.](#)

PLoS ONE 2012. To appear.



Semmelweis to Software Sepsis

1. Implantable medical devices should be trustworthy
2. Improved security will enable medical device innovation

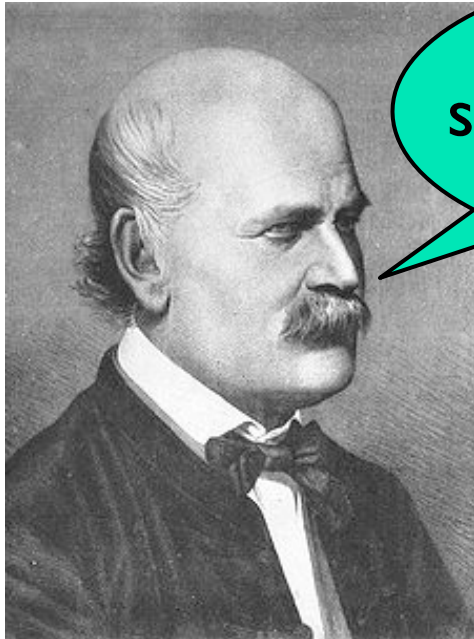

Physicians
should wash
their hands.

Doctors
are gentlemen and
therefore their hands are
always clean.



Dr. Ignaz Semmelweis
1818-1865

Dr. Charles Meigs
1792-1869



Semmelweis to Software Sepsis

1. Implantable medical devices should be trustworthy
2. Improved security will enable medical device innovation

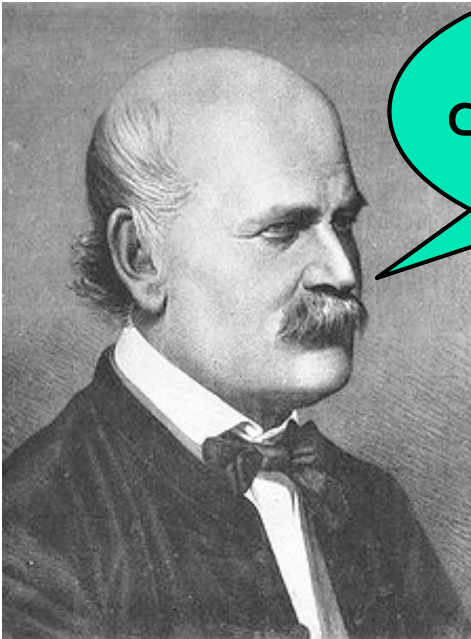

Medical devices should be secure.

You're so negative. There's no ROI on security anyway.

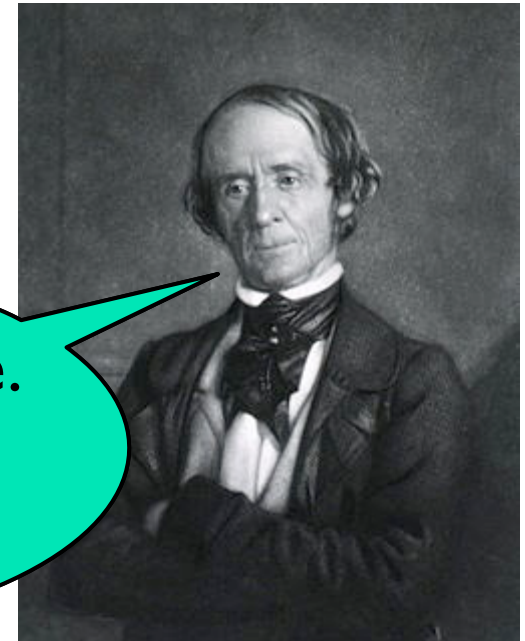

Dr. Ignaz Semmelweis
1818-1865

Dr. Charles Meigs
1792-1869



← Ways Forward ↗

Security should
be **designed** in

not **bolted** on





omdrl.org



Massachusetts
Institute of
Technology





ACM MedCOMM

Workshop on Medical Communication Systems

August 13, 2012, Helsinki, Finland

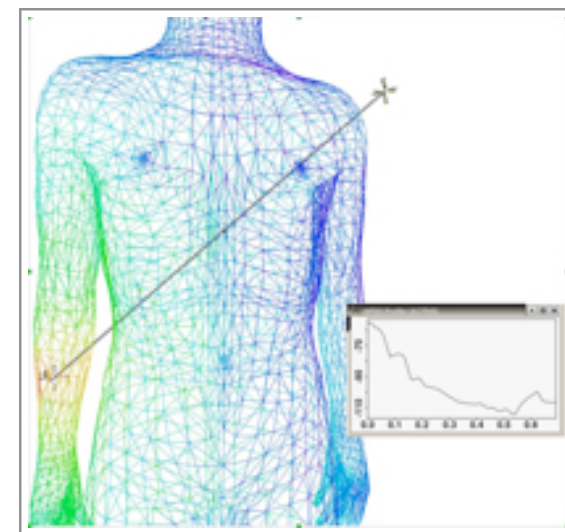
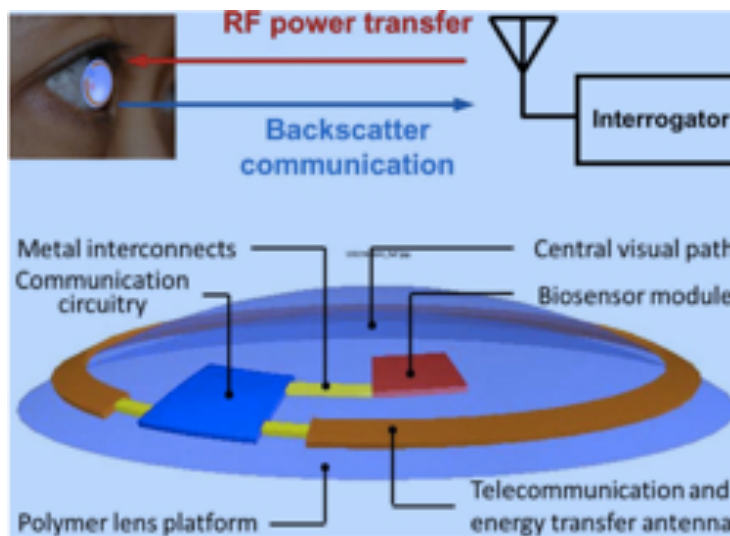
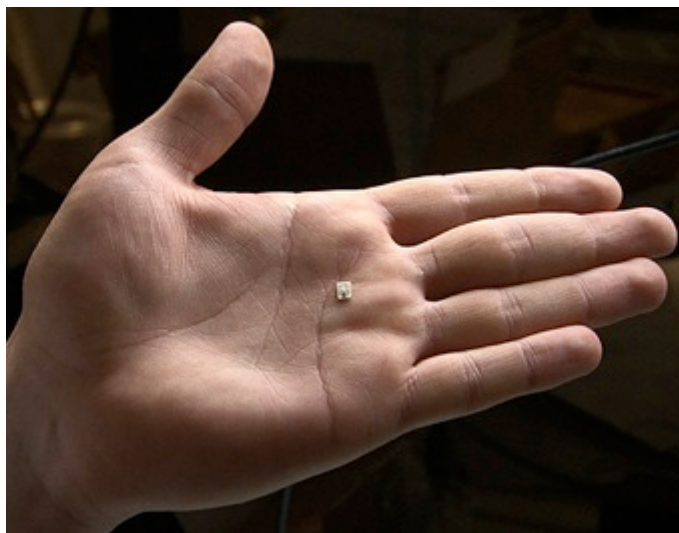
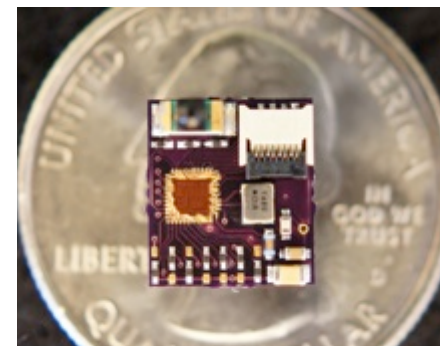

tinyurl.org/medcomm



Summary: Problem=Unavailability

- Biggest risk:
 - ~~Hackers breaking into medical devices~~
 - Wide-scale **unavailability** of patient care



Heart Safe: Cardiac Cath Labs

Three times in as many months, the computerized systems at the heart of Stanford University Medical Center's cardiac catheterization labs froze, locking up tighter than a plaque-clogged artery. Mark Addis, CBET, of the clinical technology and biomedical engineering department needed to figure out the reason why.

Soon enough, he had his answer: the information technology (IT) department had been loading third-party anti-virus software at a data center server farm, and this software was incompatible with the proprietary programming package running on the networked systems in the cardiac cath labs. "Every time IT did this, it chewed up nearly all the RAM in my systems' CPUs, which disrupted all 12 of the labs at the same time," Addis says, whose main responsibility at the Palo Alto, Calif, hospital is the care and feeding of those rooms.

http://www.24x7mag.com/issues/articles/2008-09_03.asp



Summary: Problem=Unavailability

- Biggest risk:
 - ~~Hackers breaking into medical devices~~
 - Wide-scale **unavailability** of patient care



As you are aware, [...] an unknown virus was found in the [Cath Lab] system. Our [vendor] worked late into Christmas Eve in order to keep the **infected [Cath Lab devices] isolated**. As a proactive measure and to prevent our patients from inappropriate release of protected healthcare information the hospital **immediately blocked** our access to the **internet**. Today [it was] announced that they have traced the **virus** path from [a] **nursing workstation**. Apparently **pictures were uploaded** from a **USB drive to yahoo**.

- Security can't be bolted on. Build it in: requirements, design, implementation, post-market surveillance, etc.

